

Kuance
STUDIO

SURFACES

NUANCE STUDIO

Welcome to Nuance Studio, the pinnacle of luxury concrete design.. At Nuance Studio, we believe that luxury is not just seen—it's experienced. We've taken Concrete material often associated as a basic construction material and transformed it into something truly extraordinary. Our state-of-the-art production facilities ensure that each product, whether it's wall panels or bespoke furniture, meets the highest standards of quality and finesse. Experience the future of luxury with Nuance Studio



LITHEOZ CONCRETE

Litheoz concrete is revolutionizing the industry by offering features far beyond conventional concrete. Engineered with advanced technology, Litheoz can be custom-molded into various forms and homogeneously pigmented to achieve a diverse range of colors and textures. Developed through intricate processes and balanced formulations rooted in German technology, Litheoz has become a game-changer in the world of concrete. As an Ultra High Performance Fiber Reinforced Concrete, Litheoz redefines the potential of concrete, merging cutting-edge technology with unparalleled aesthetic appeal. Discover how Litheoz sets a new standard in concrete design and innovation.

CONTENTS

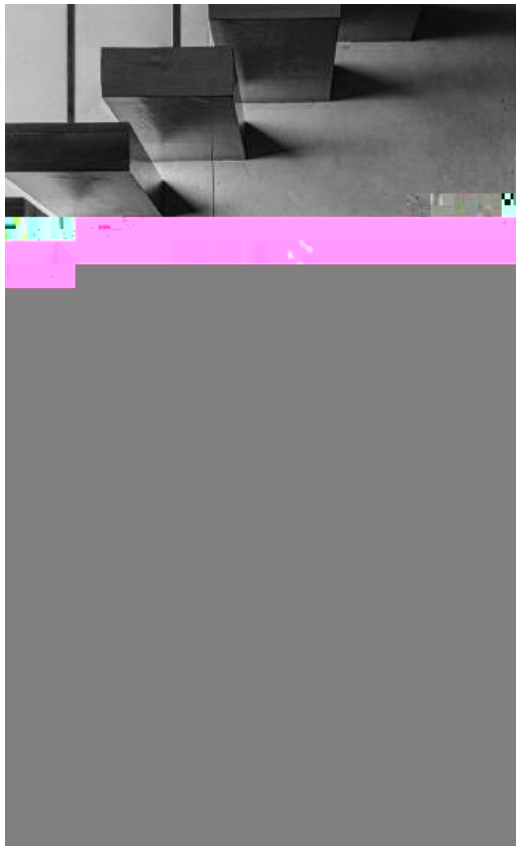

FLAT SERIES	001
NATURAL	004
POROUS	006
TRAVERTINE	008
DISTRESSED	010



DESIGNER SERIES	013		
FIBONACCI	015		
FUJI	022	PEEL RT	058
MORSE	028	PEEL SQ	064
MOBIUS STRIP	031	BENDT HUMP	067
CUBOS	037	TRANSLUMIERE BRICKS	072
BARADO	043	LINEA	078
SWAVE	048	MEGAHOUND	085
SQUAMA	054	WOODEN SLATS	090



FLUTED SERIES	096
DORIC	098
PALARIC	104
CONFINI	110
RIBBED	115



ILLUMINATE SERIES	121
HALO ECLIPSE	124
VERTIGLOW	130

TEXTURES	135
COLORS	136
HANDLING AND STORAGE	137
TECHNICAL SPECIFICATIONS	138
INSTALLATION PROCEDURES	139



FLAT SERIES

Introducing Flat
Litheoz Concrete Wall
Panels, the epitome
of modern elegance
and versatility for both
interior and exterior
design projects.



NATURAL

Sleek and minimalist design effortlessly complements any architectural style, from contemporary chic to industrial charm. Reflecting the true aesthetics of concrete, the mottling tones, shade variations, and naturally occurring pinholes enhance the unrefined presence of the Natural Textures offered by Nuance Studio.

POROUS

Small pores and bug holes here and there without any consistent number make the Porous textured flat panels by Nuance Studio the minimal aesthetic standout texture.

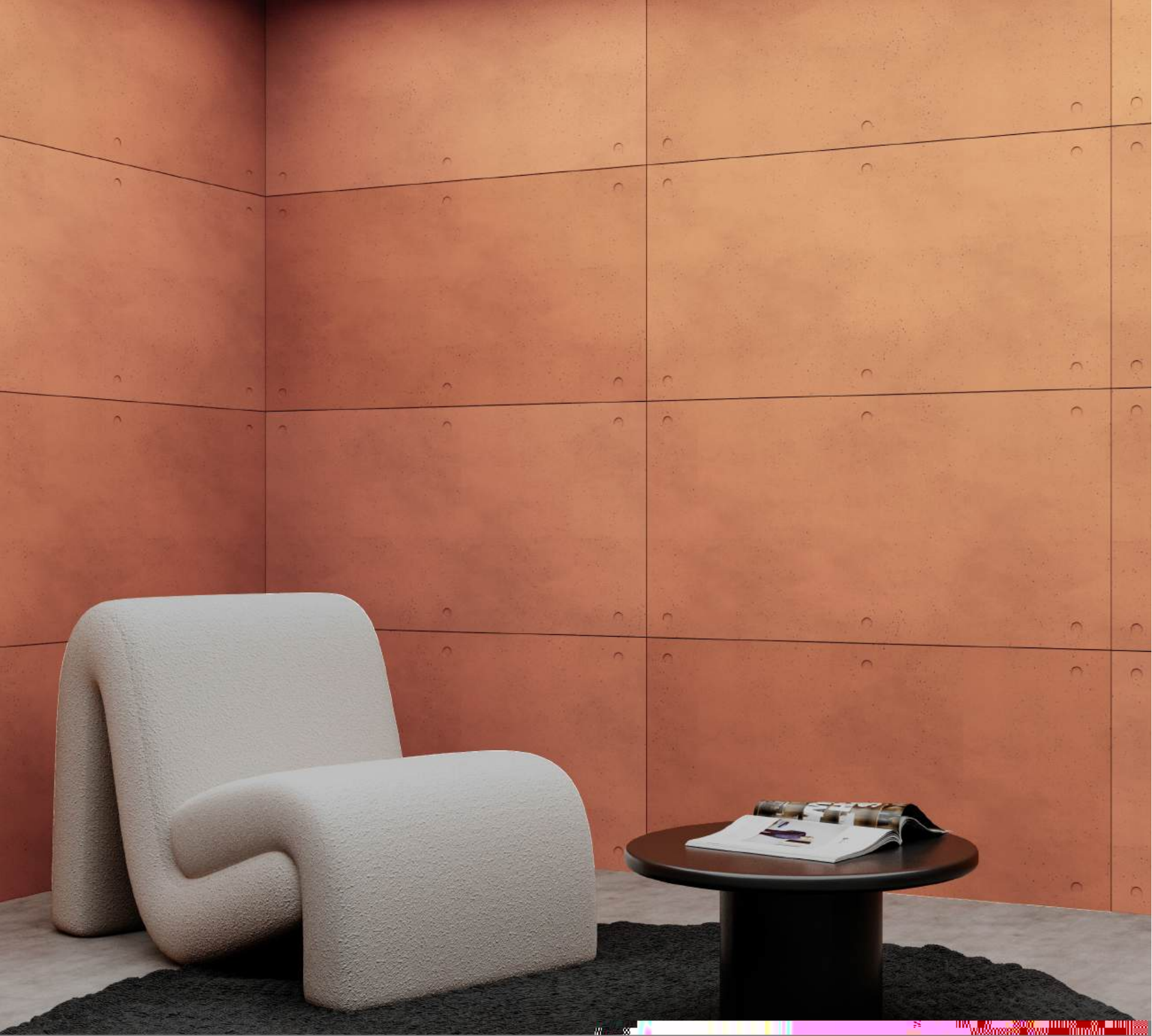

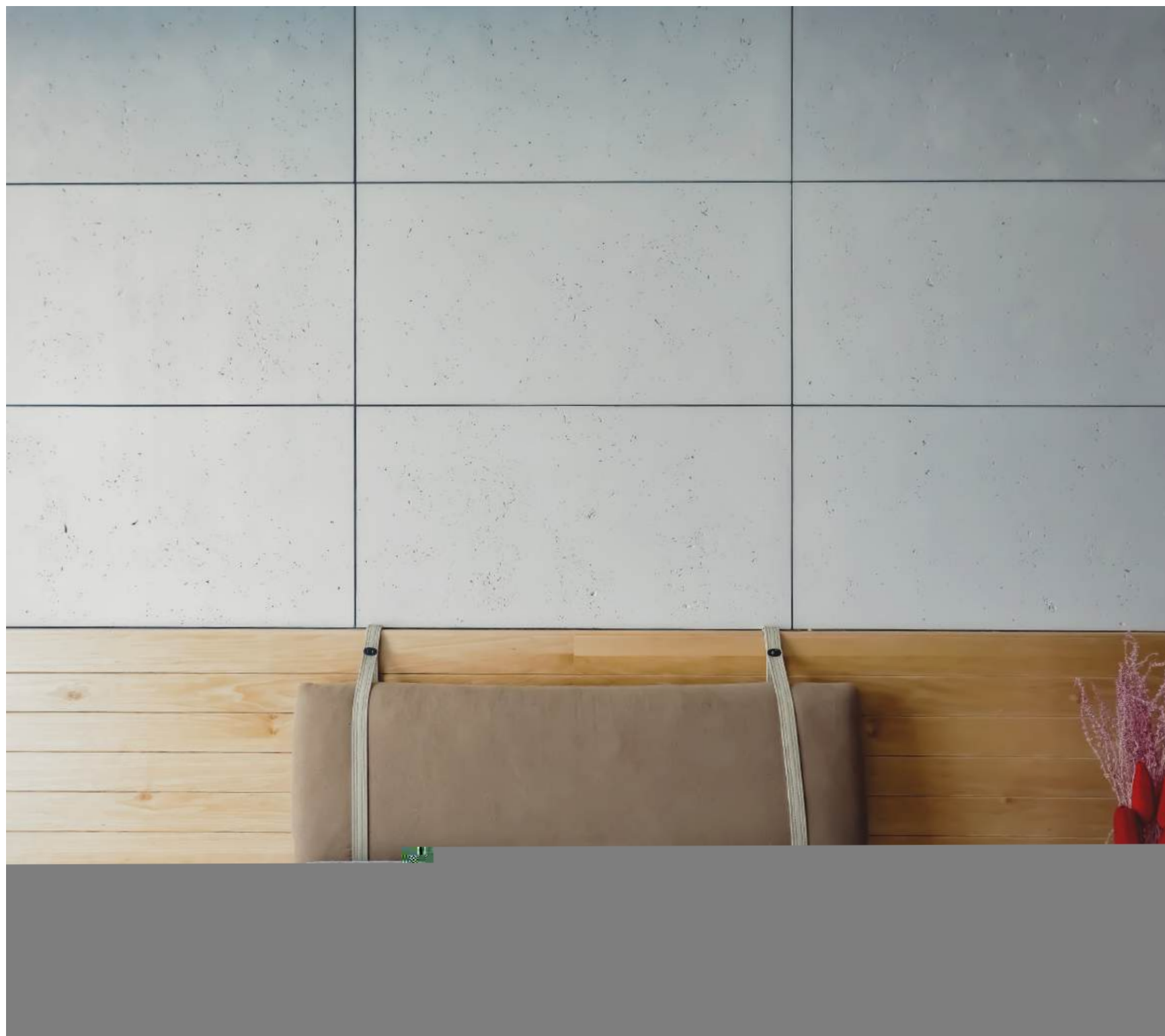

TRAVERTINE

Discover the timeless allure of Travertine Wall Panels, leaving a captivating charm to both indoor and semi-indoor spaces. Crafted with meticulous attention to detail, these panels feature elements and holes strategically integrated into their texture during manufacturing, evoking an organic, unrefined aesthetic that seamlessly harmonizes with contemporary design motifs.

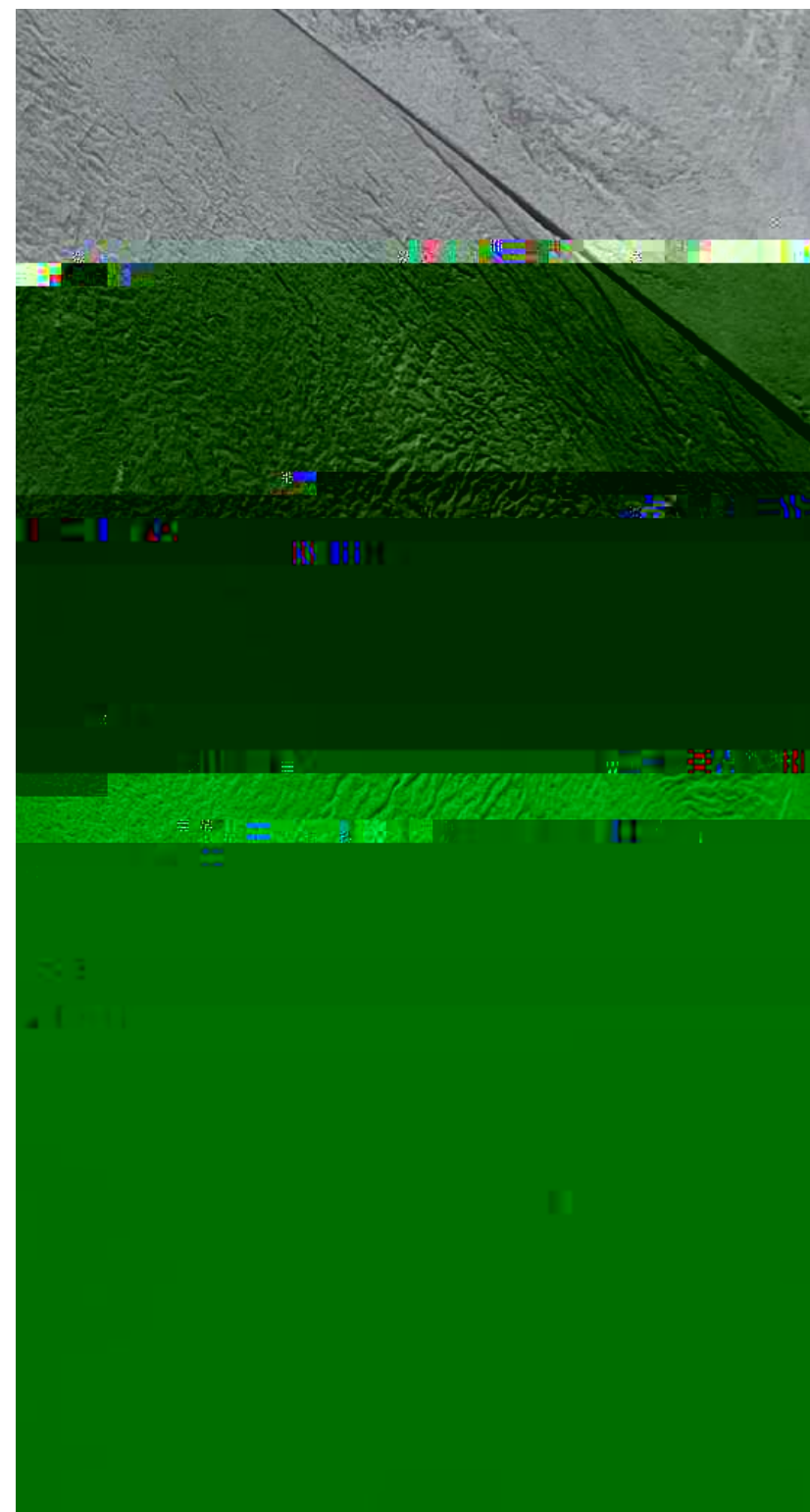
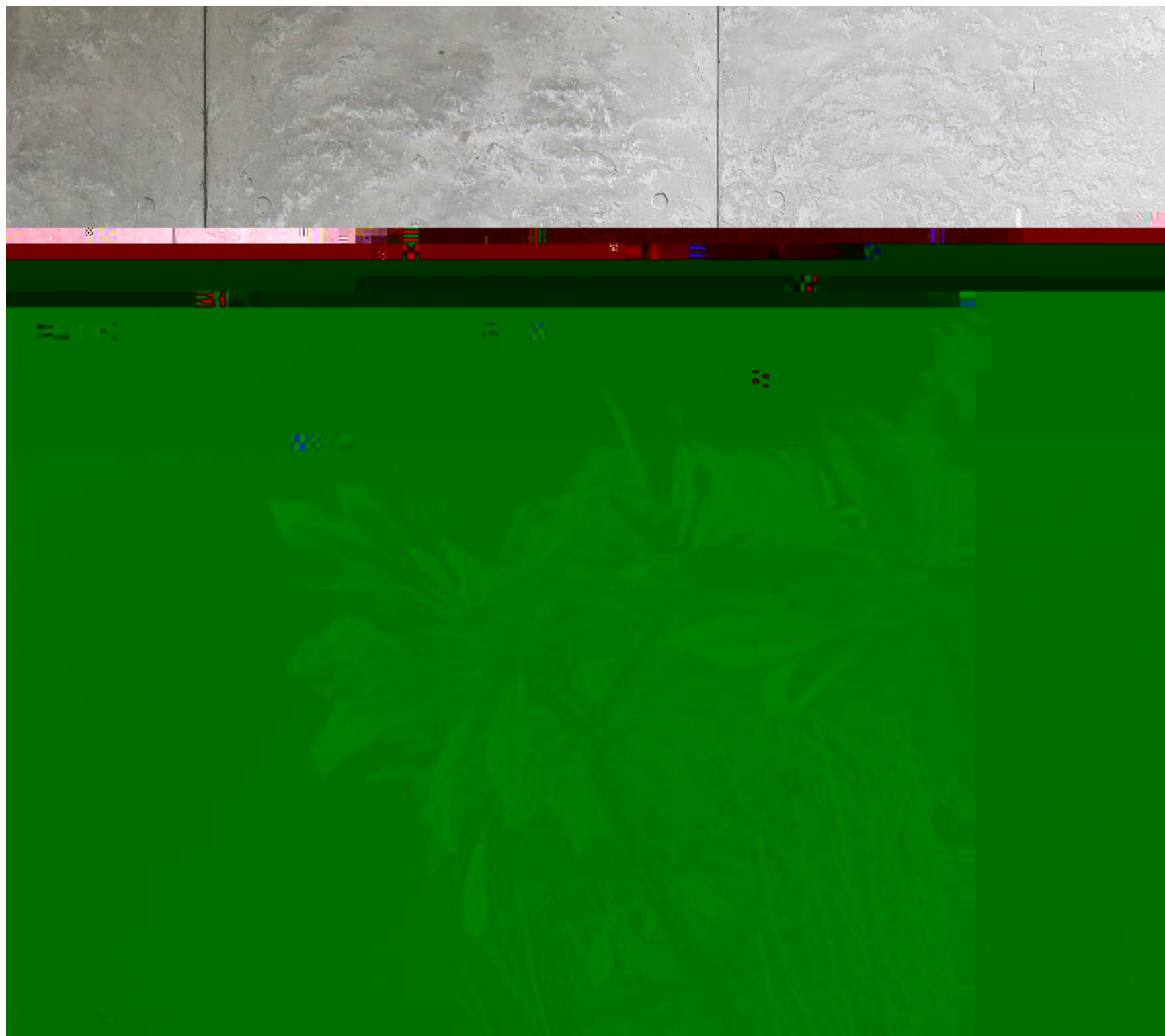

DISTRESSED

Crafted to perfection, the Distressed Wall Panels by Nuance Studio offer a rugged yet refined allure that effortlessly complements rustic design schemes. Ideal for those who seek to infuse their spaces with a sense of raw authenticity, these panels are the epitome of rustic sophistication.

DIMENSIONS

MODULES

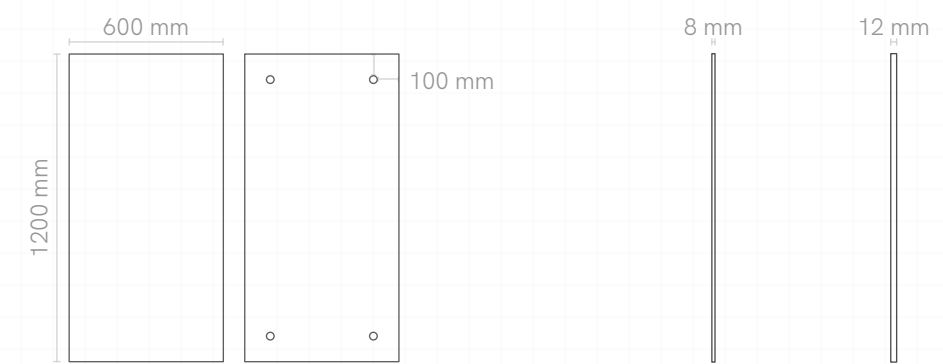
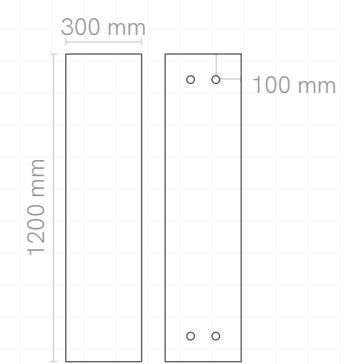
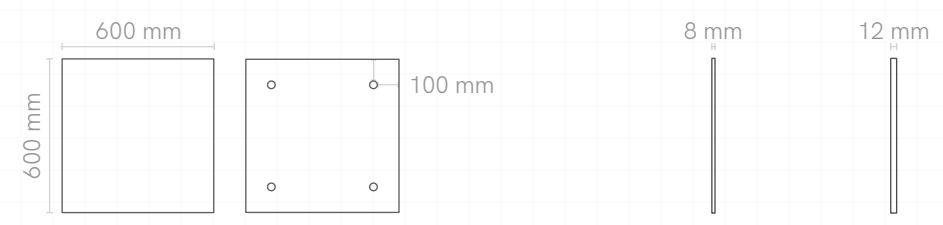

CORNER DETAILS

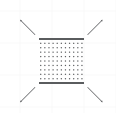
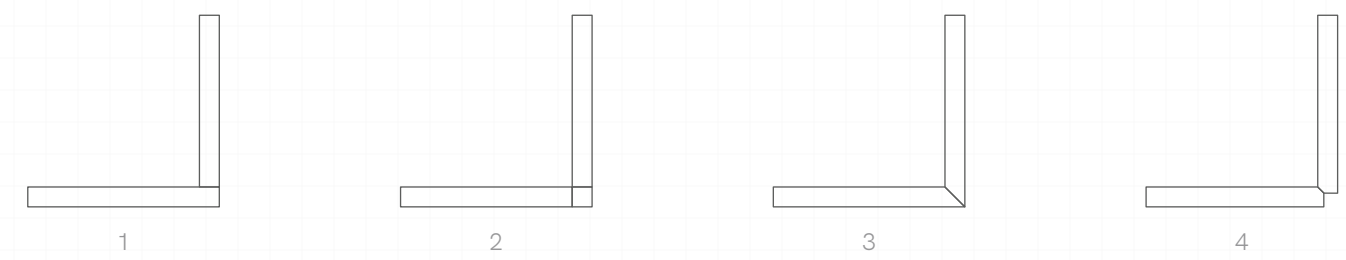

X- LARGE FORMAT

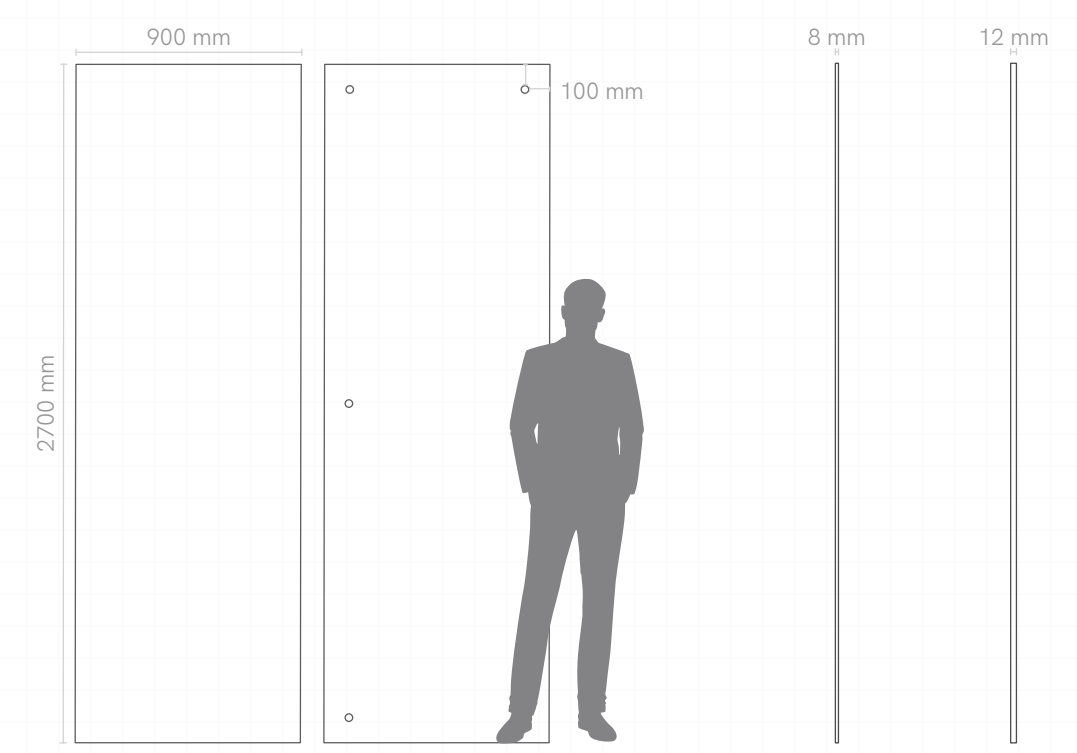
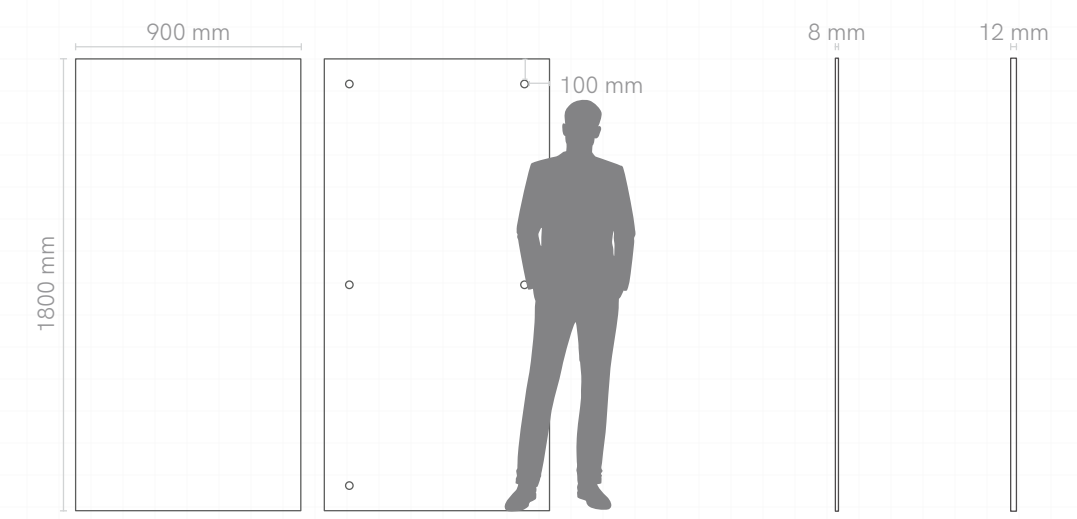



DESIGNER SERIES

Step into a realm where concrete transcends its conventional boundaries, emerging as a symbol of opulence and sophistication. Each panel in our Designer Series is a masterpiece of design ingenuity, meticulously curated to exude an aura of exclusivity and prestige.

FIBONACCI

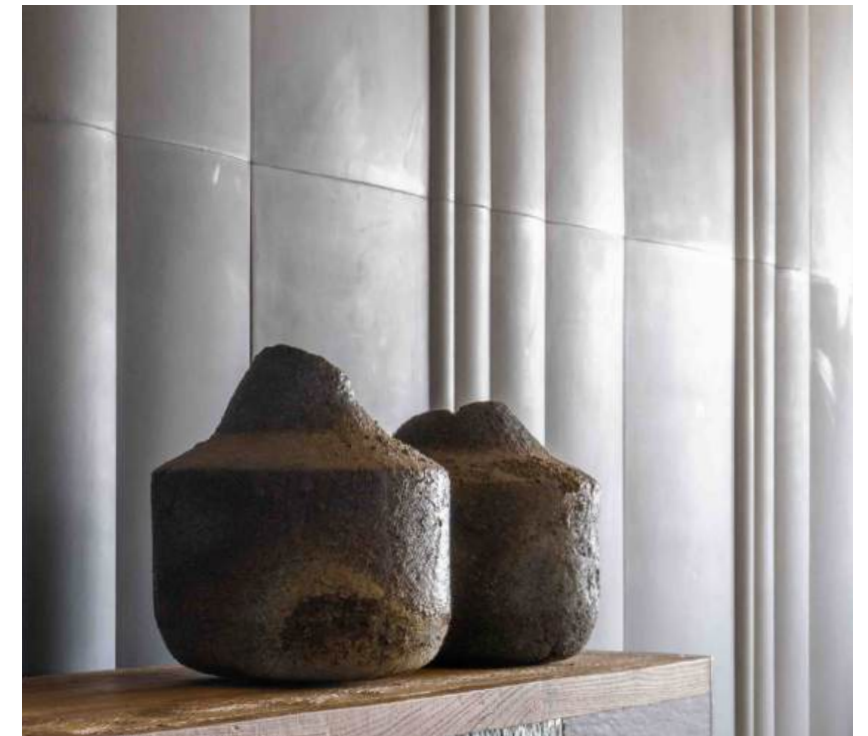
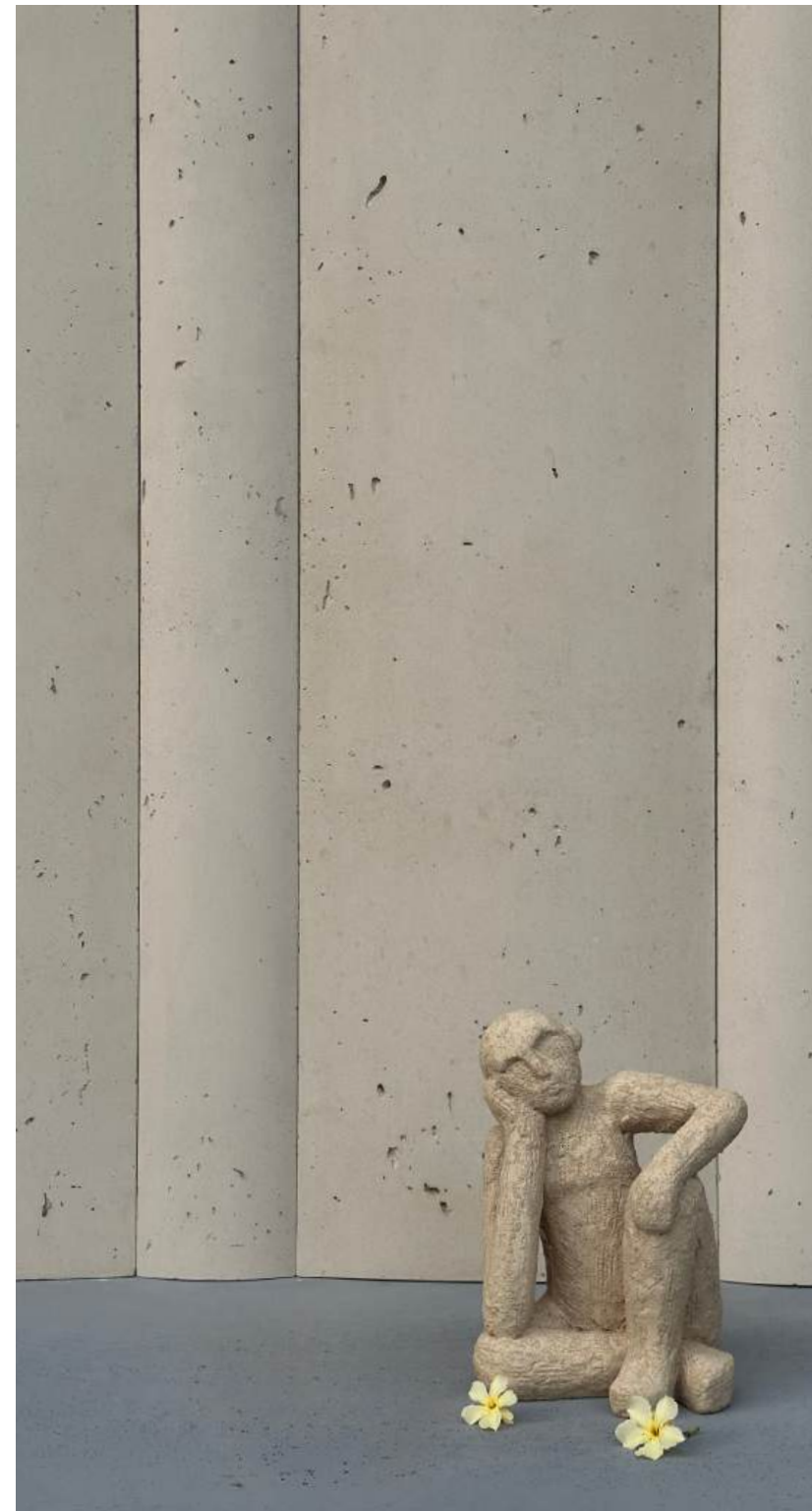

Designer: Saif Faisal

Indulge in the allure of Fibonacci Series by Nuance Studio, where each installation transcends mere functionality to become a symphony of visual delight. Derived from the revered Fibonacci principle, each panel's width embodies timeless perfection, lending a touch of divine proportion to your surroundings.

Experience the perfect blend of form and function with the Fibonacci Series, where every installation is a testament to luxury and refined taste.



DIMENSIONS

MODULES

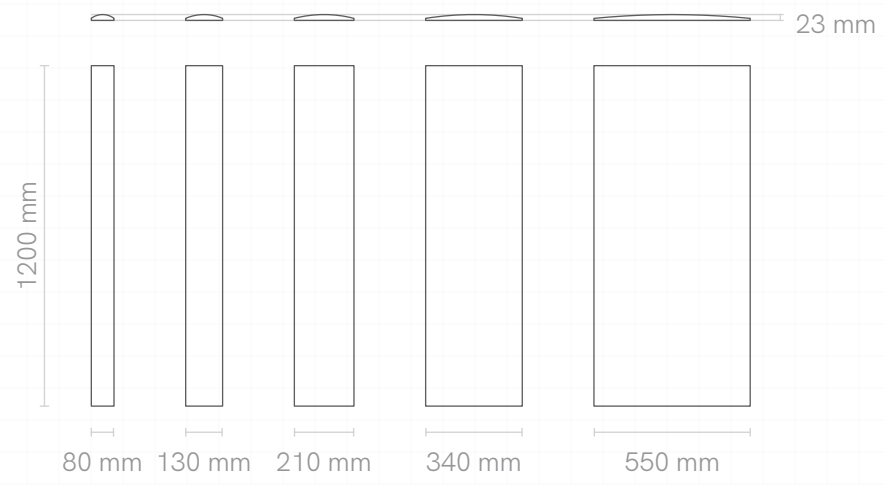

LARGE FORMAT

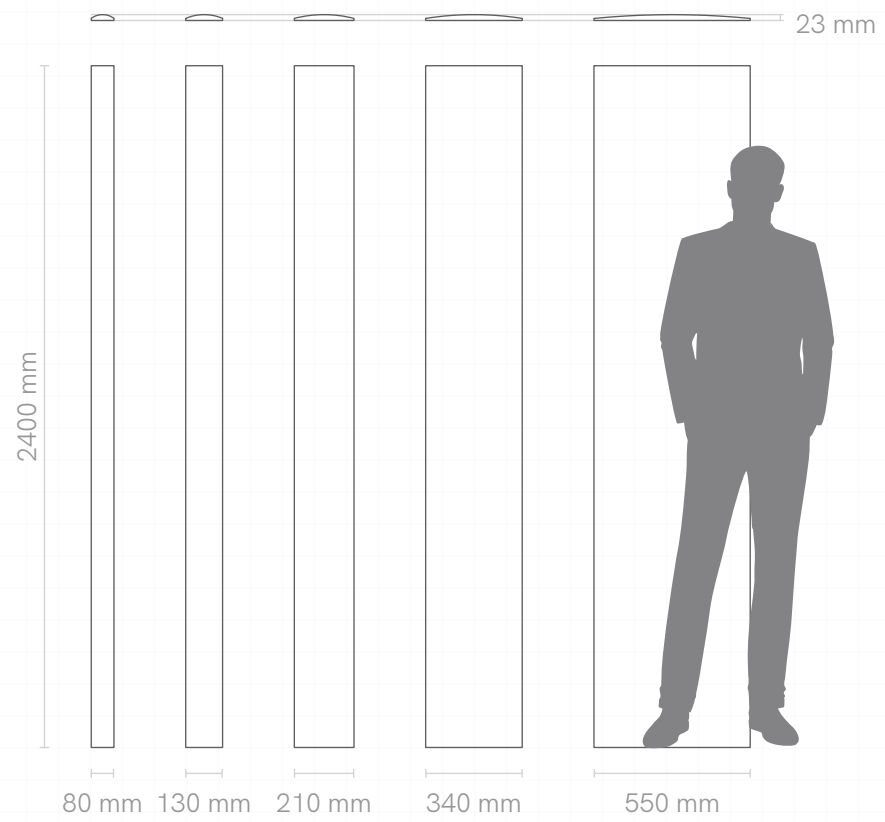

INSTALLATION PATTERNS

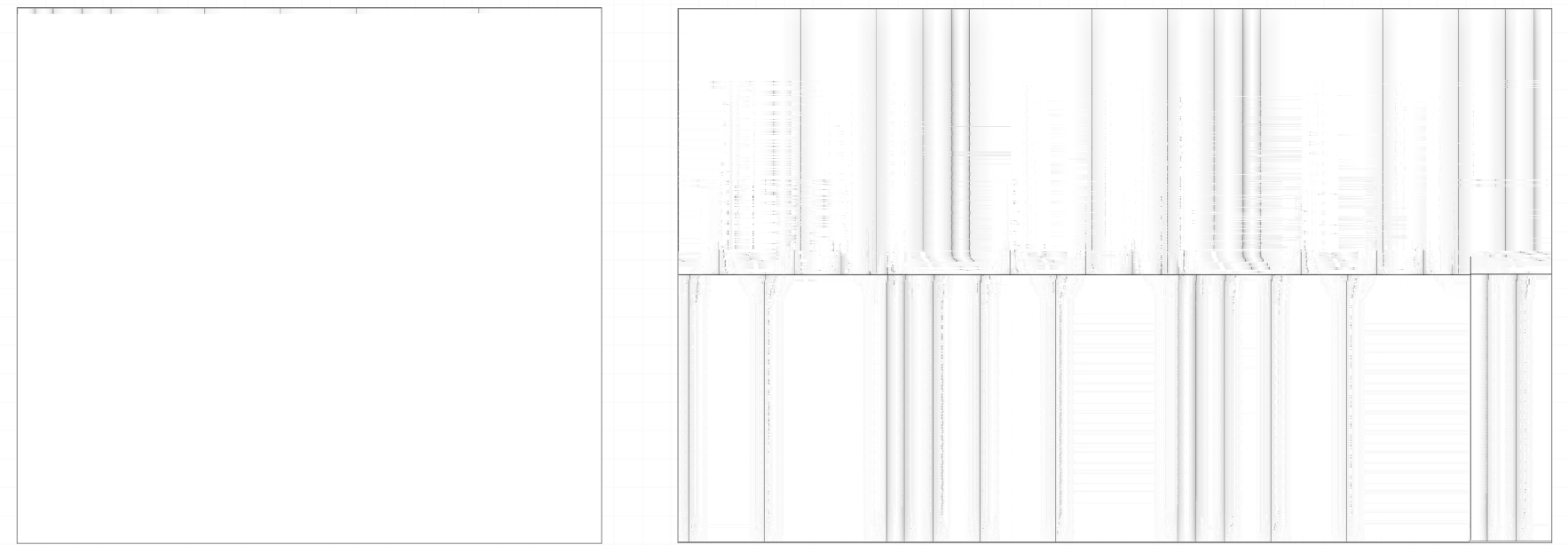
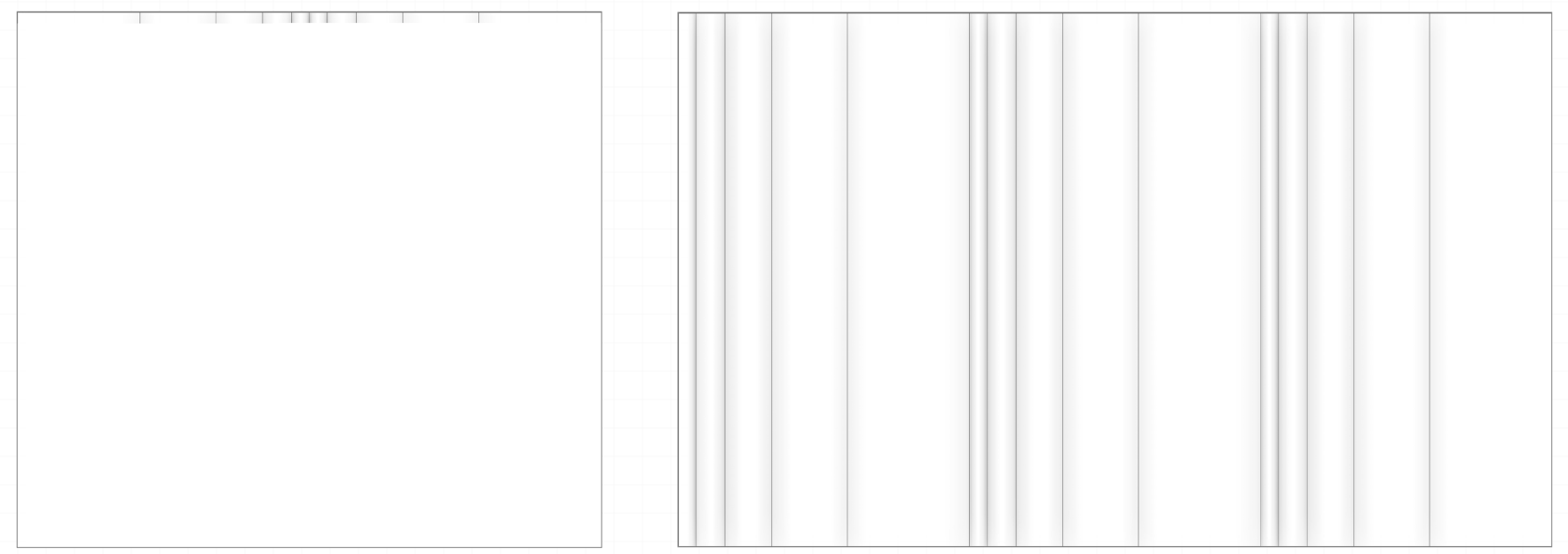



Experience the sublime elegance of our Mount Fuji Inspired Wall Panel Collection, meticulously crafted to evoke the poetic reflections of Japan's iconic landmark. Drawing inspiration from the serene beauty of Mount Fuji's reflection in the five lakes and the timeless artistry of Katsushika Hokusai's Ukiyo-e paintings, each panel captures the essence of nature's majestic allure.

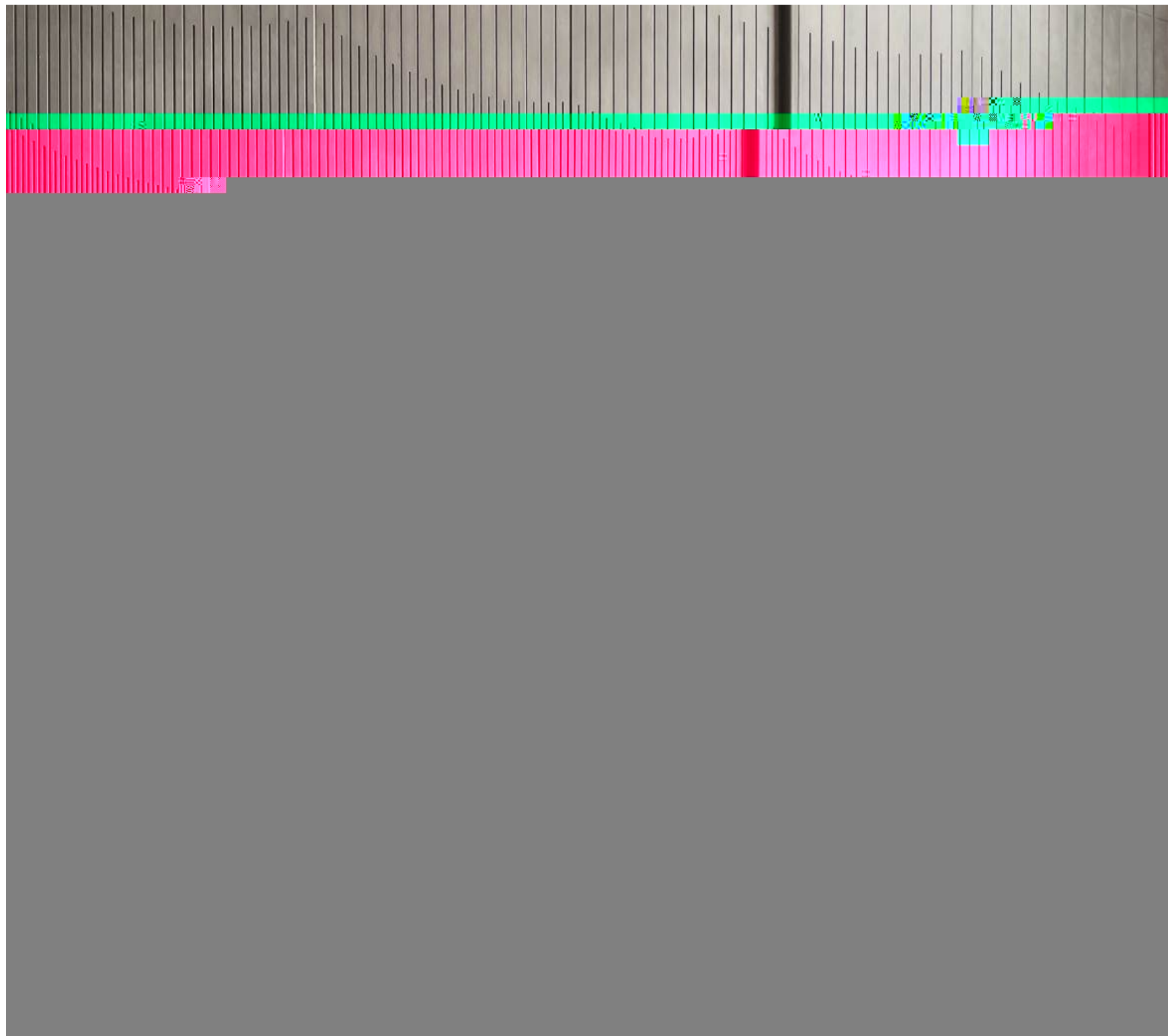

DIMENSIONS

MODULES

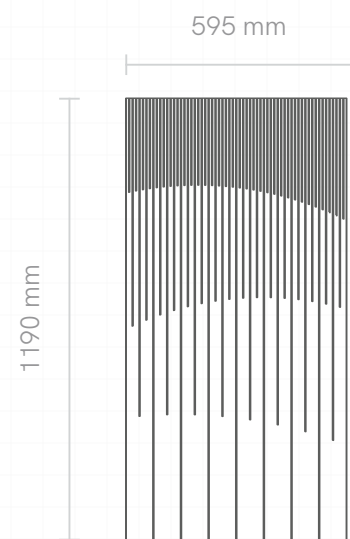

Fuji_L

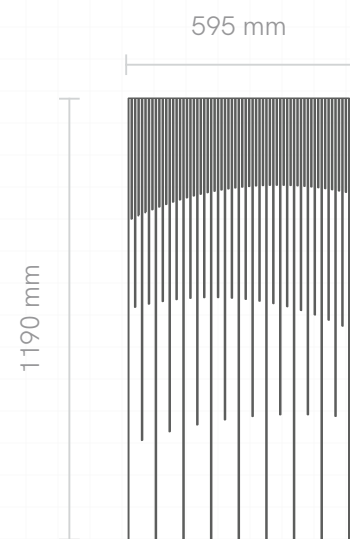

Fuji_R

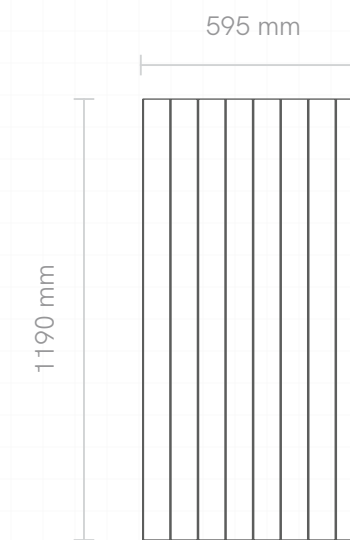

Fuji_S

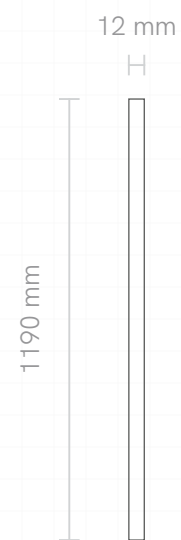

INSTALLATION PATTERNS

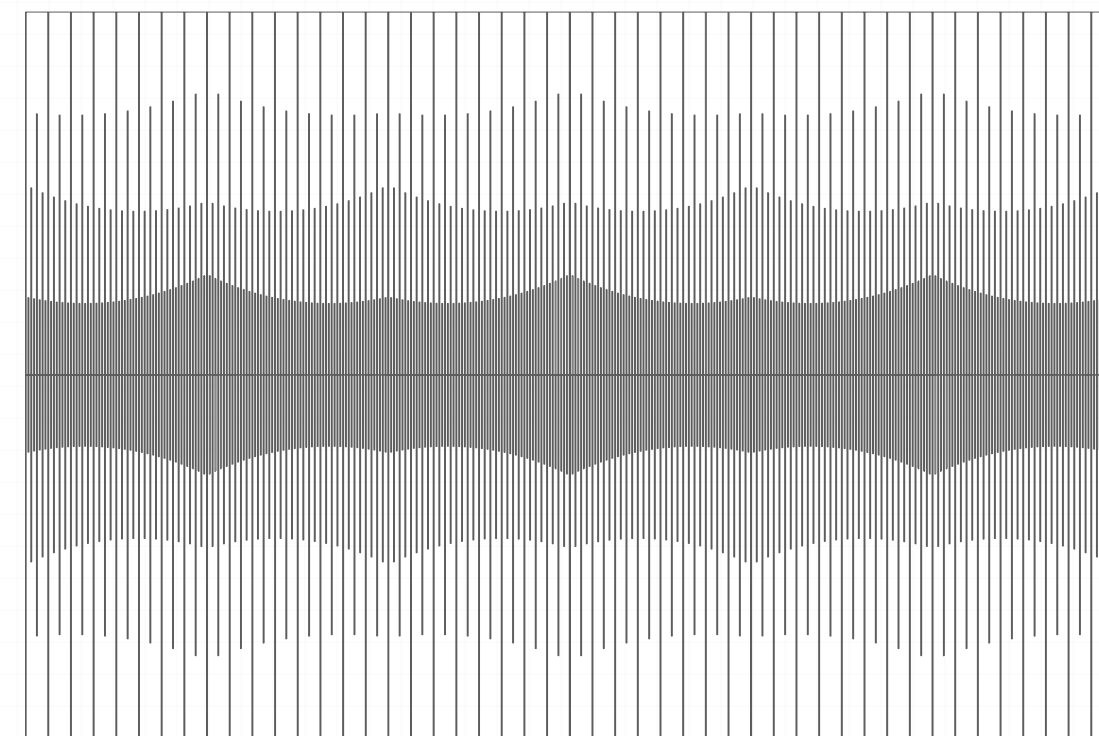
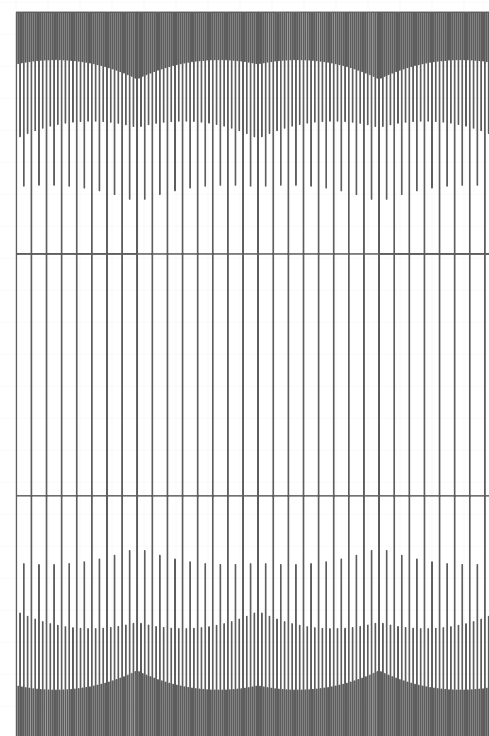
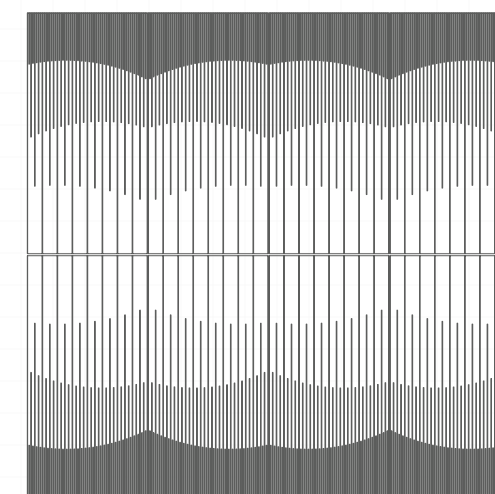
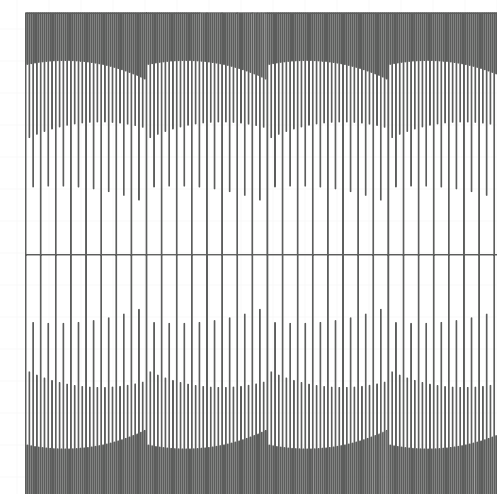
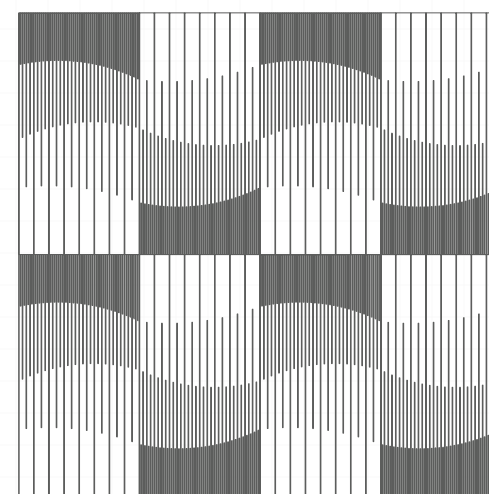

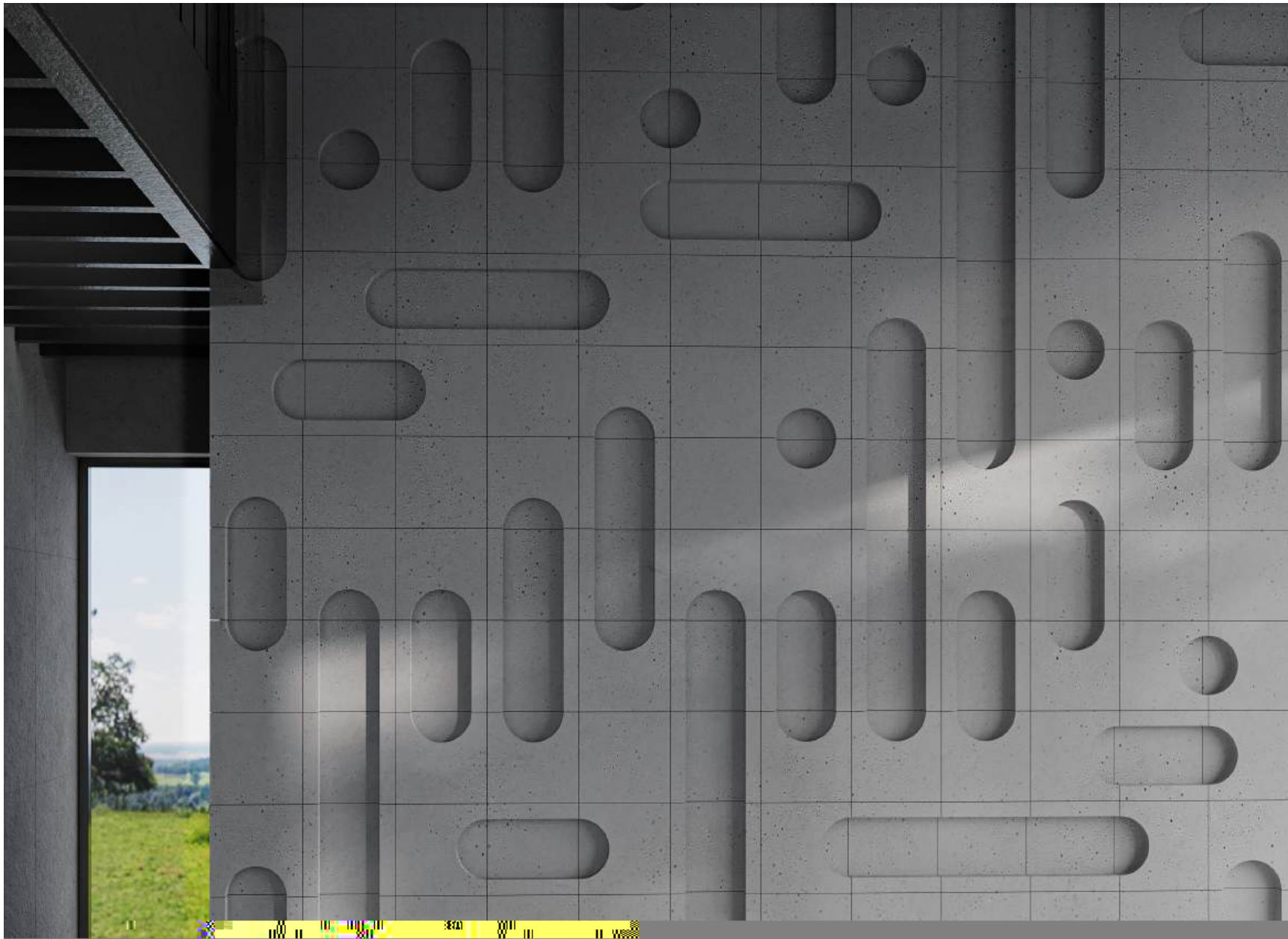

MORSE



Designer: Purple Ink Studio

Introducing Morse Code Concrete Wall Panels: where simplicity meets sophistication in the language of geometry. Inspired by the elemental components of design - the point and the line - these panels speak volumes with minimalist elegance. Much like Morse code, they communicate with subtle precision, offering a tasteful addition to any interior or exterior space.



DIMENSIONS

MODULES

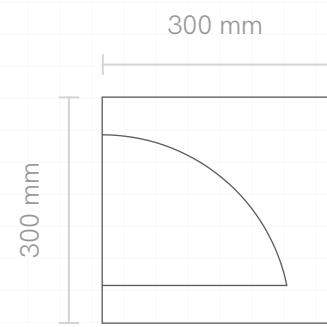

Arc_01

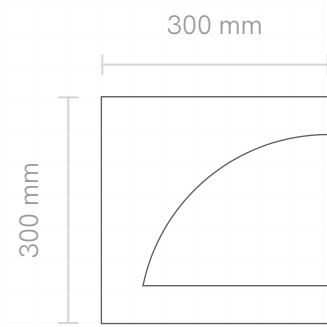

Arc_02

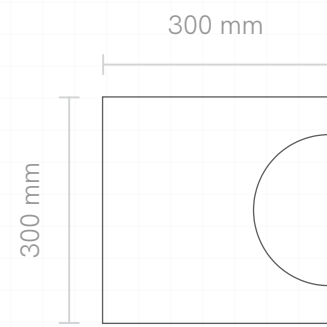

Circle

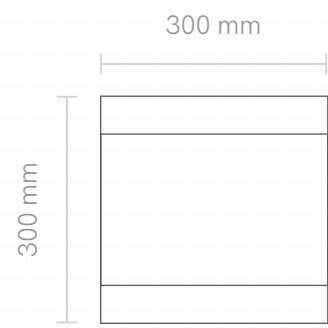
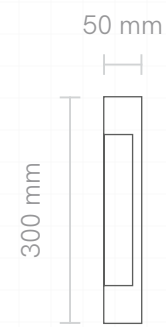

Straight

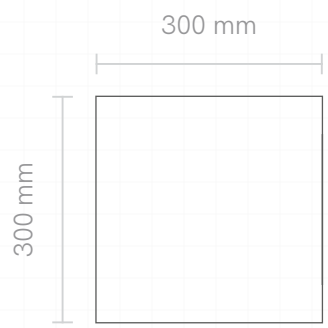
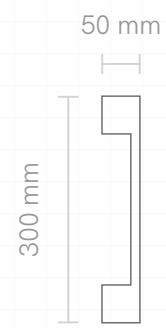

Plain

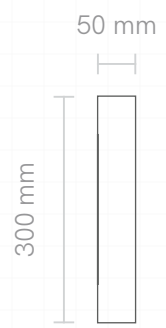

INSTALLATION PATTERNS

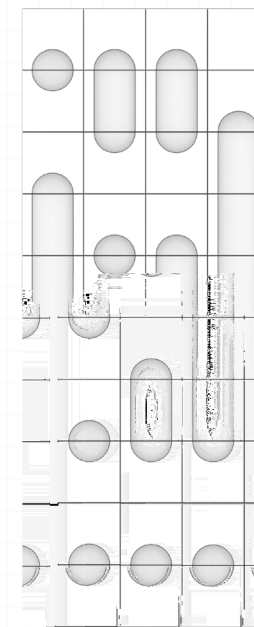
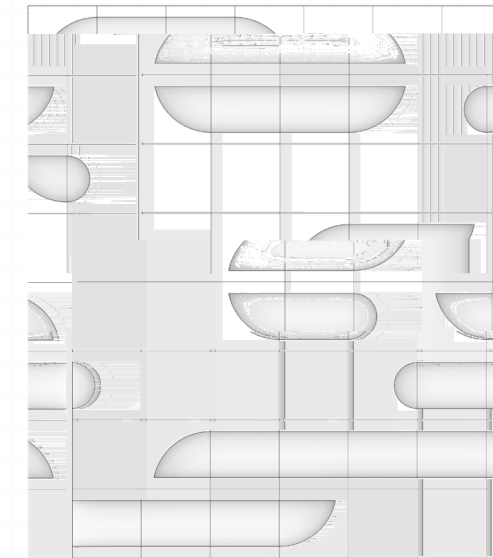
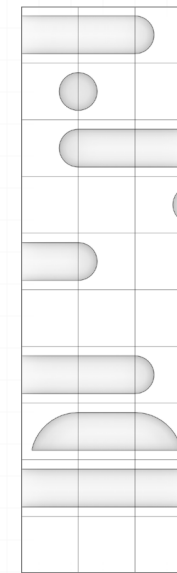

MOBIUS STRIP

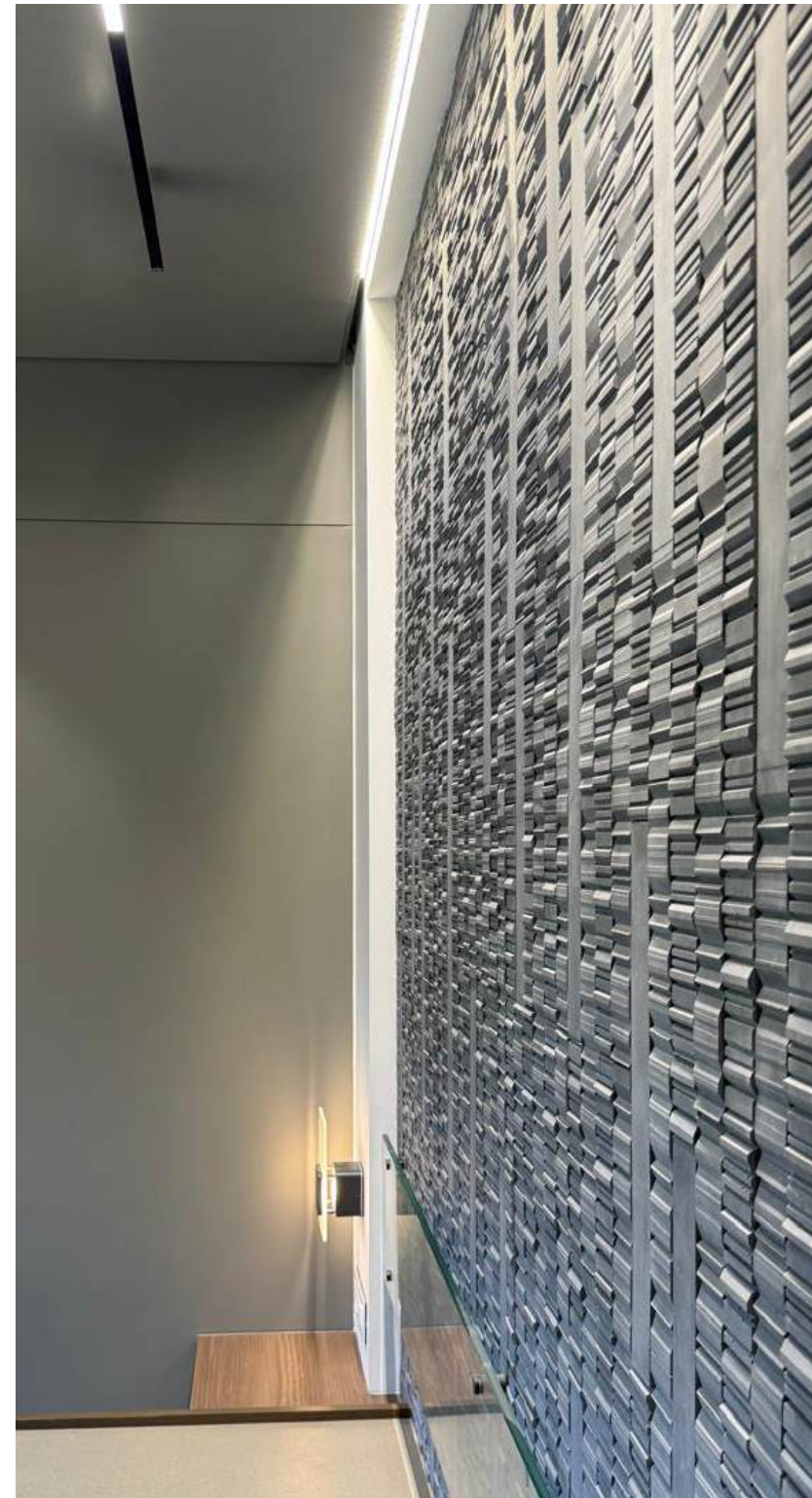

Designer: Sumesh Menon

The **Mobius Strip** design traces an infinite journey across the panel, mirroring the nonlinear nature of our experiences. Attempt to follow its path in a linear fashion, and you'll find yourself adrift in its endless twists and turns. Similarly, a tilted perspective only adds to the enigma, as focus slips away amidst its seamless transition.



DIMENSIONS

MODULES

INSTALLATION PATTERNS

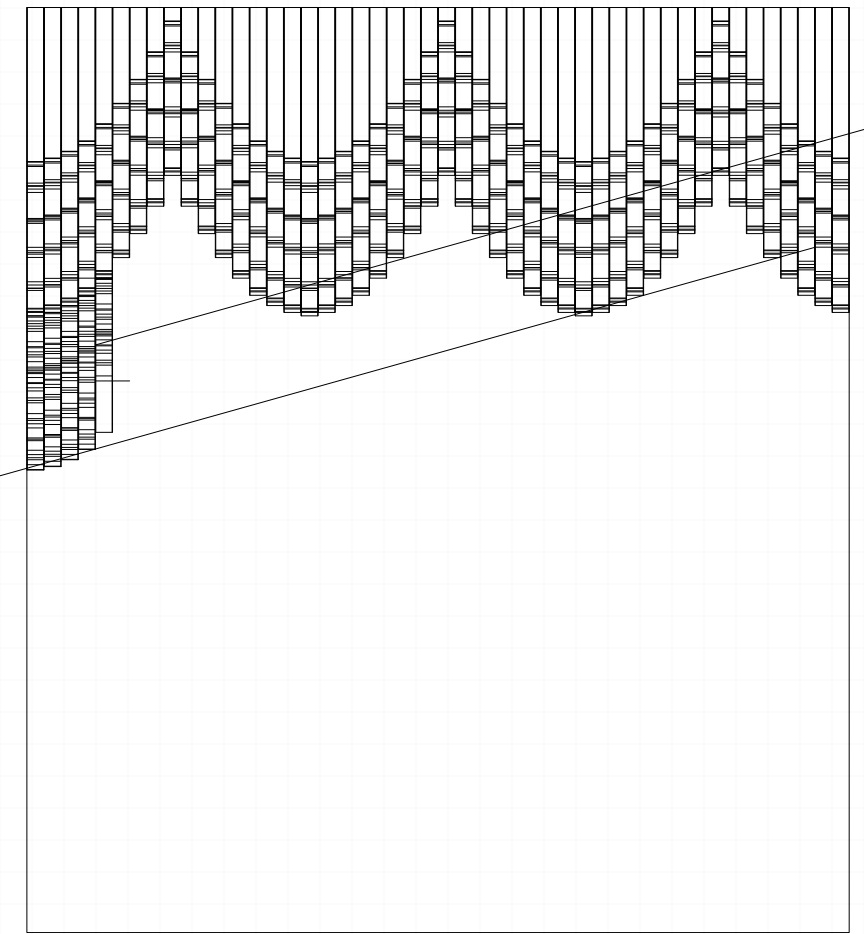
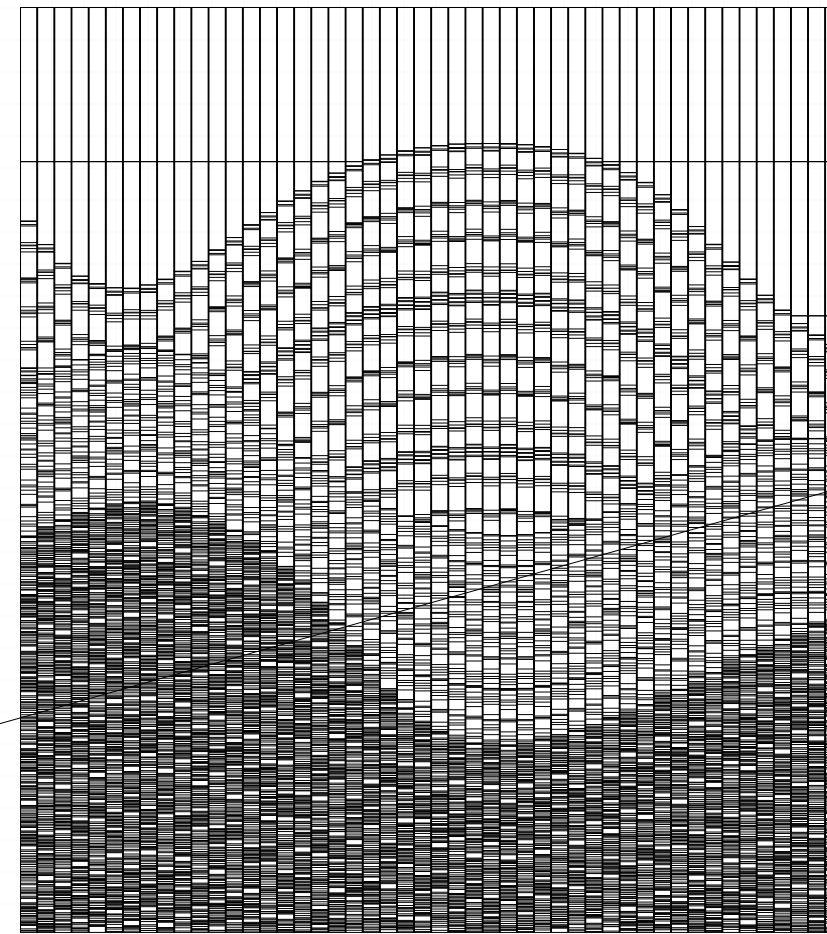



CUBOS

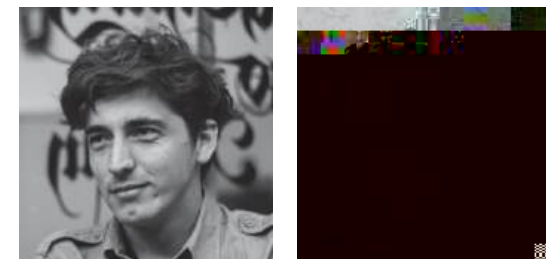

Designer: Diego and Leonardo (Argentina)

Cubos Wall Panel is a harmonious fusion of sophistication and versatility. Crafted with meticulous attention to detail, this minimalist masterpiece features a singular element infinitely repeated, creating a timeless aesthetic that seamlessly integrates into any space. Inspired from the geometric cubes, the Cubos by Nuance Studio is an innovation.

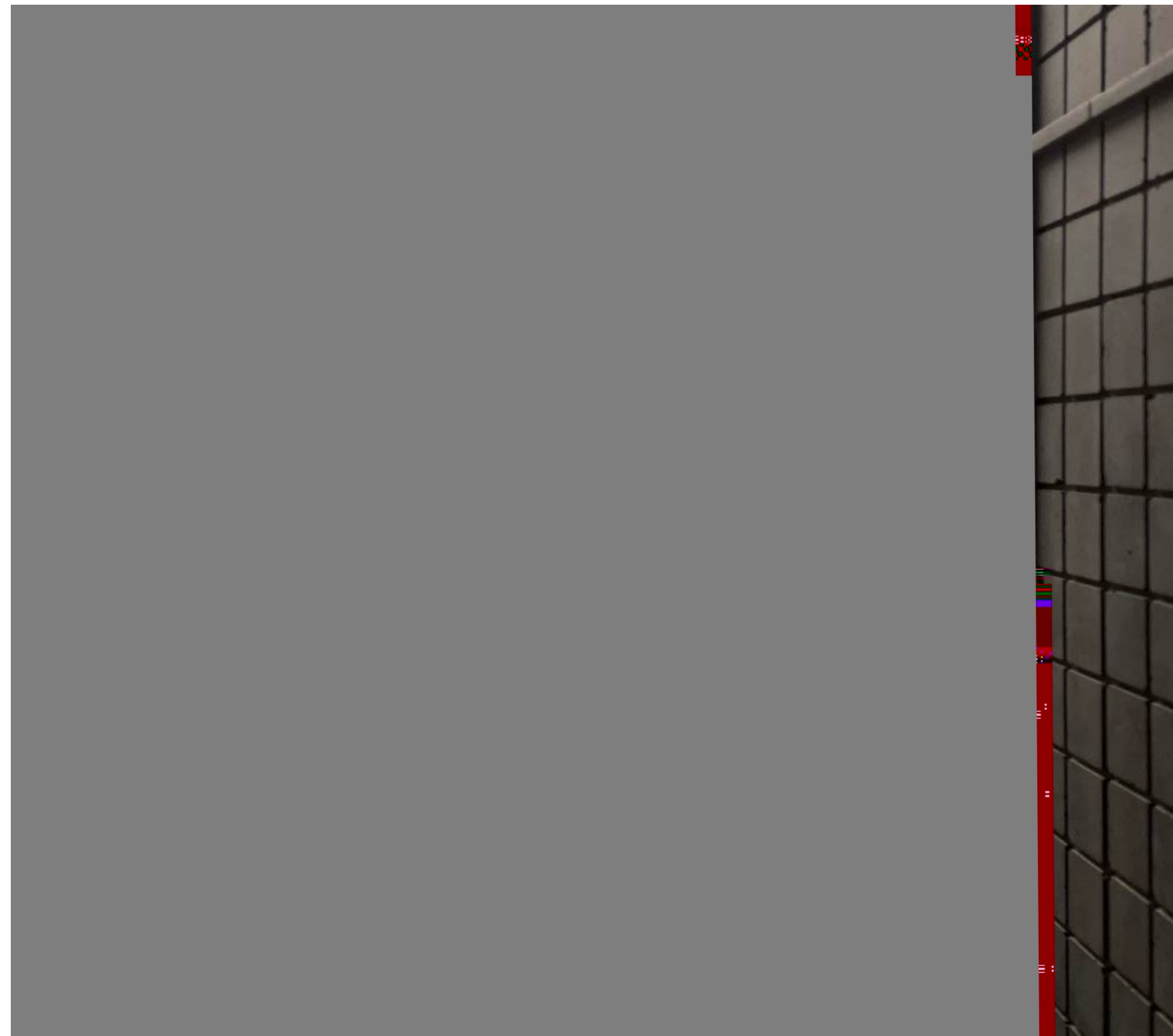
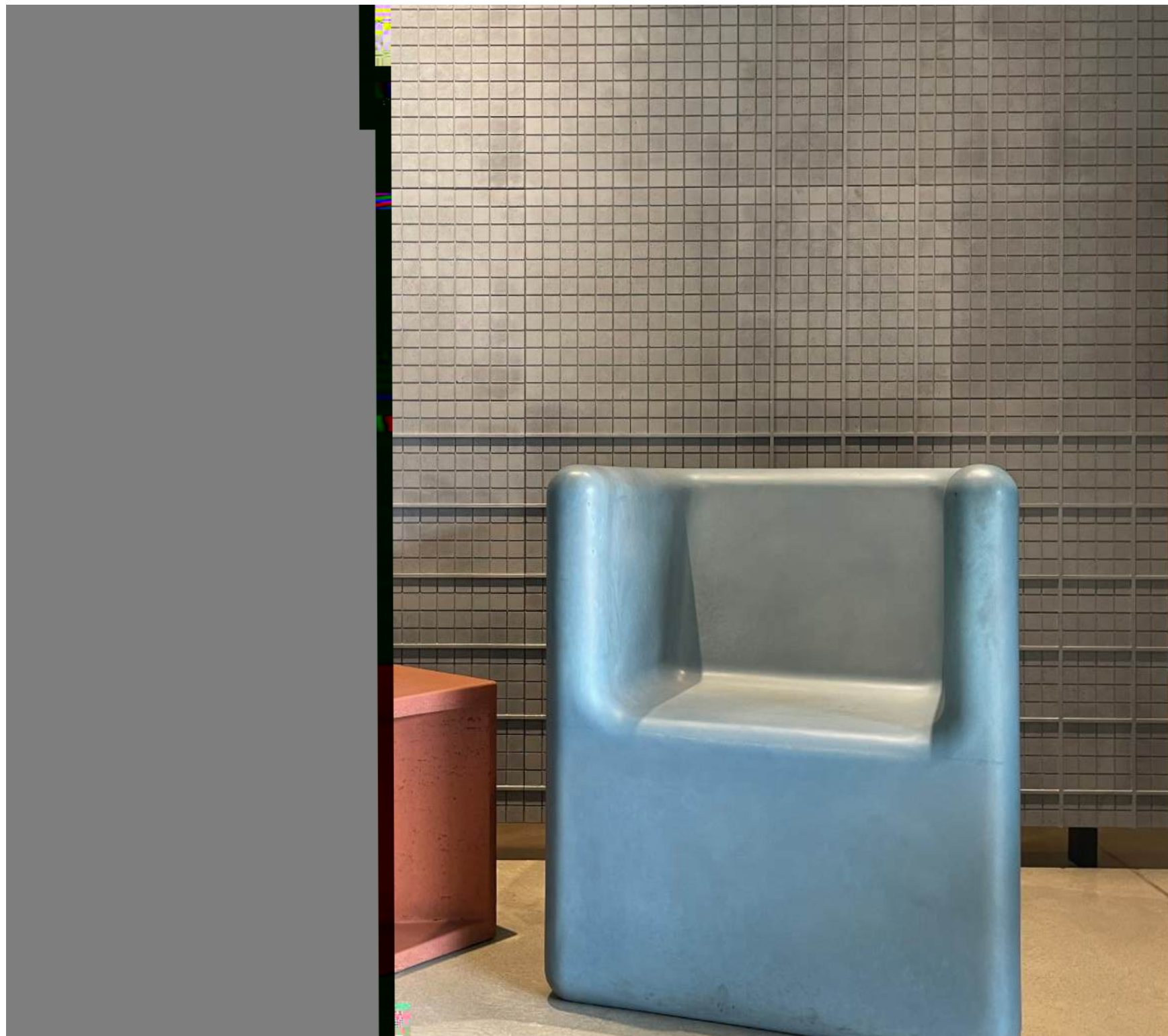

DIMENSIONS

MODULES

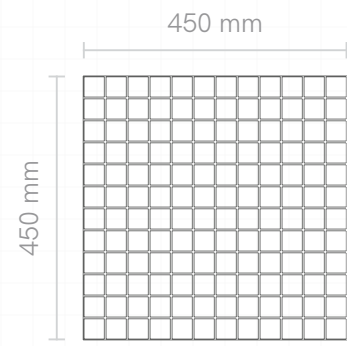
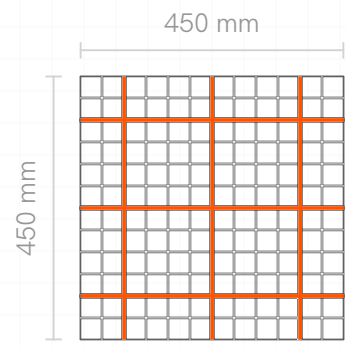
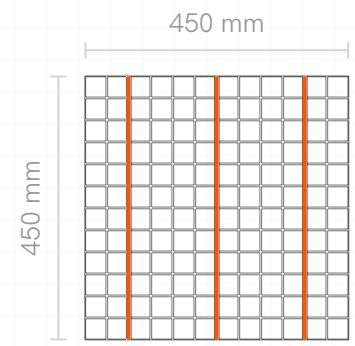

22 mm \pm \pm 12 mm

1D

22 mm \pm \pm 12 mm

2D

15 mm \pm \pm 12 mm

0D

INSTALLATION PATTERNS

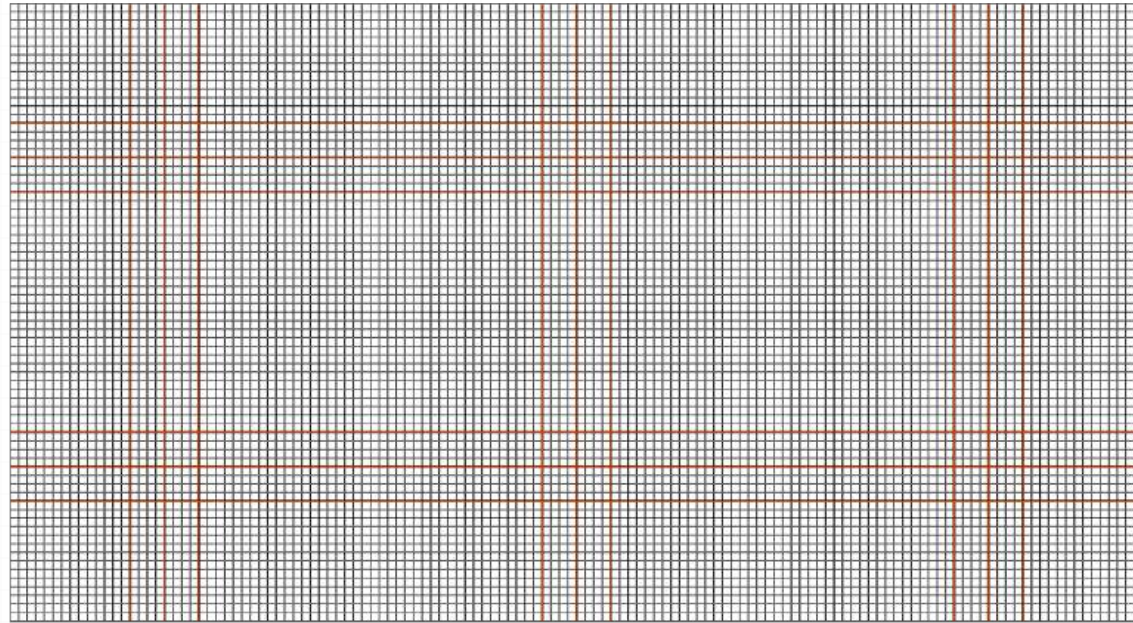
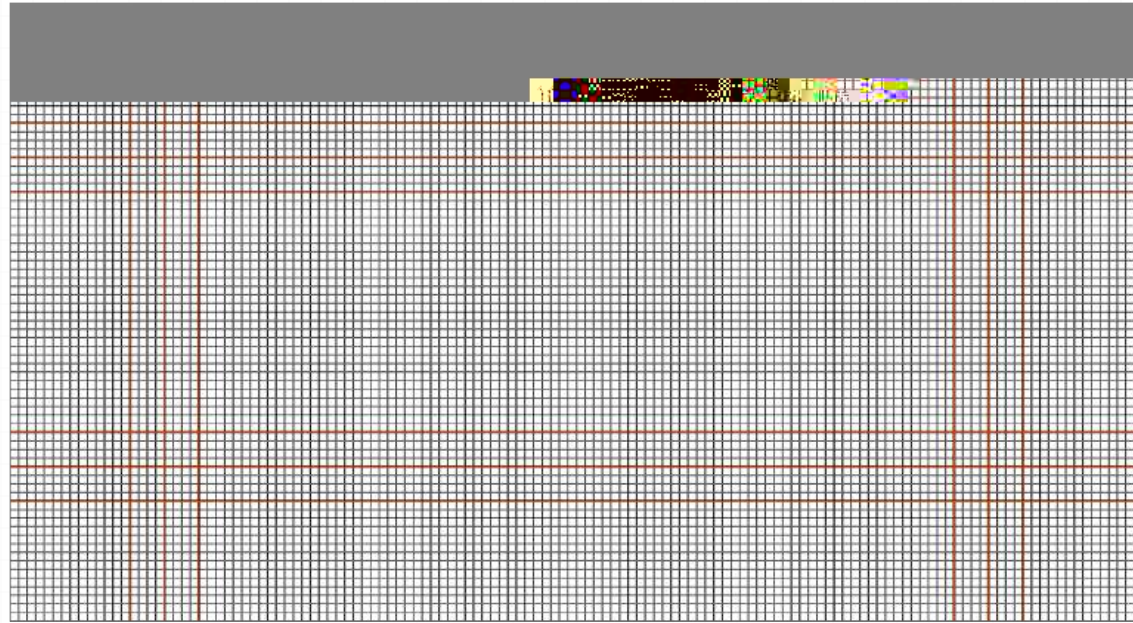

BARADO

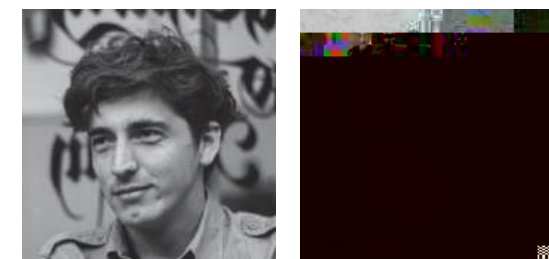

Designer: Diego and Leonardo (Argentina)

Introducing BARADO: Our Designer Geometric Wall Panel, a pinnacle of elegance and versatility. Crafted with minimalist precision, BARADO seamlessly integrates into any space, creating a sophisticated ambiance with a delicate interplay of light and shadow.

DIMENSIONS

MODULES

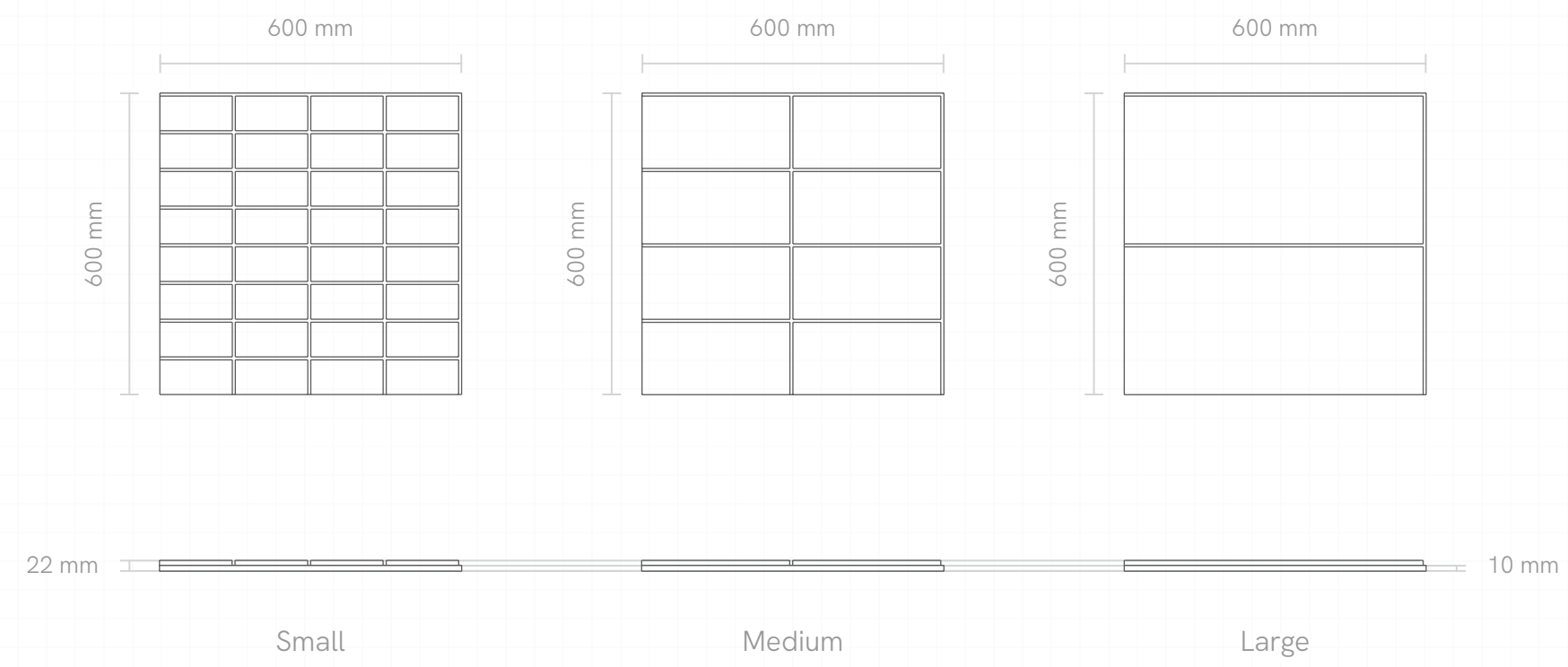

INSTALLATION PATTERNS

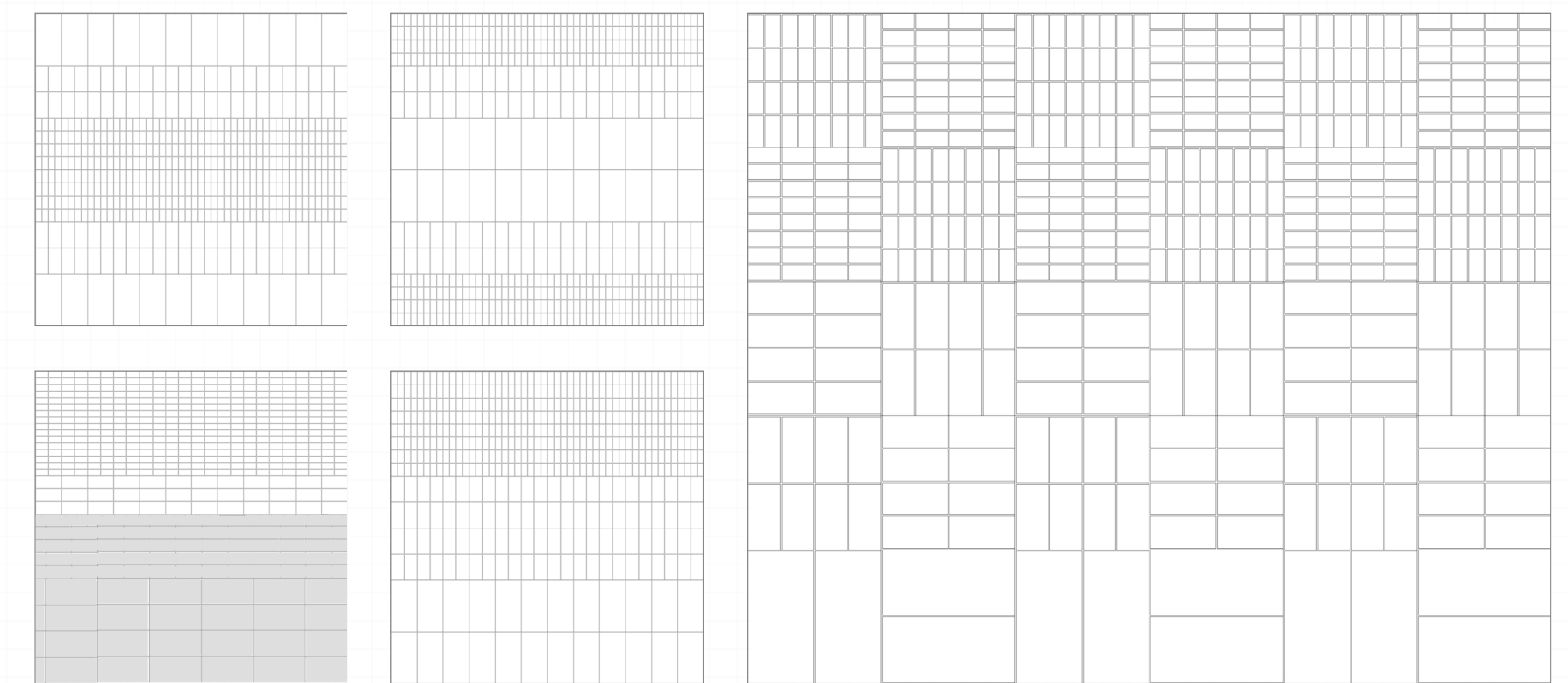

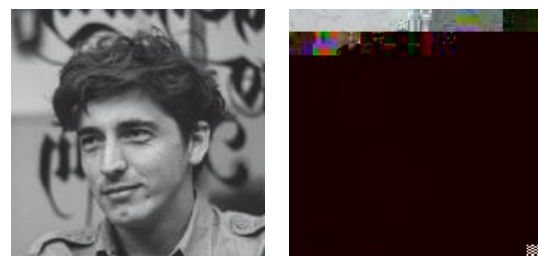

Designer: Diego and Leonardo (Argentina)

Swave wall panels by Nuance Studio epitomizes elegance with a natural, orthogonal line pattern achieved through innovative spatial transformation. This decorative module is perfect for both residential and commercial applications, offering a sophisticated touch to any living room or modern facade.

Its unique character ensures a distinct visual appeal, while its user-friendly nature allows even novices to create stunning patterns effortlessly. The Swave design provides endless possibilities, making it an excellent choice for those seeking to elevate their spaces with a premium, versatile aesthetic.



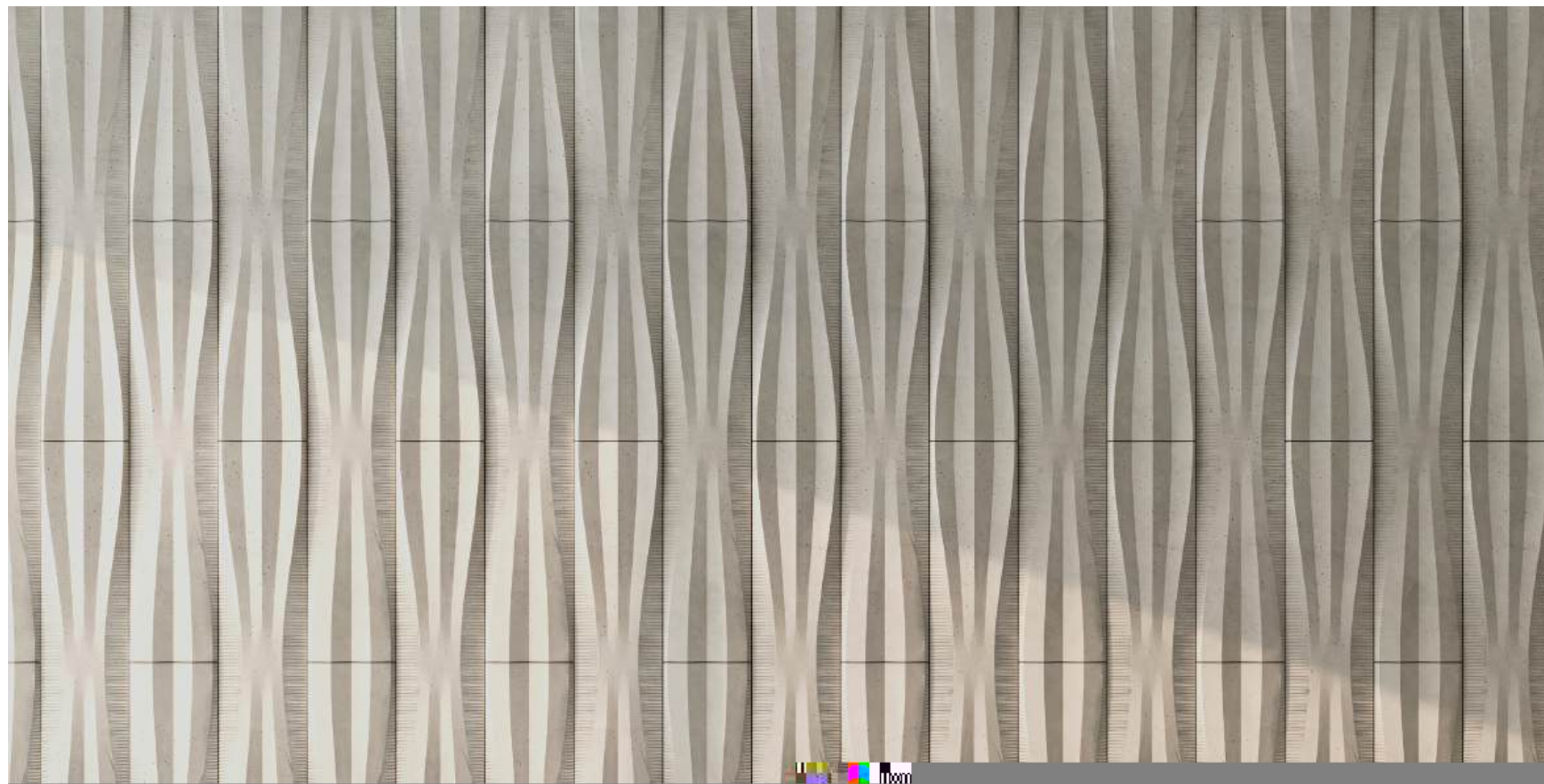

DIMENSIONS

MODULES

INSTALLATION PATTERNS

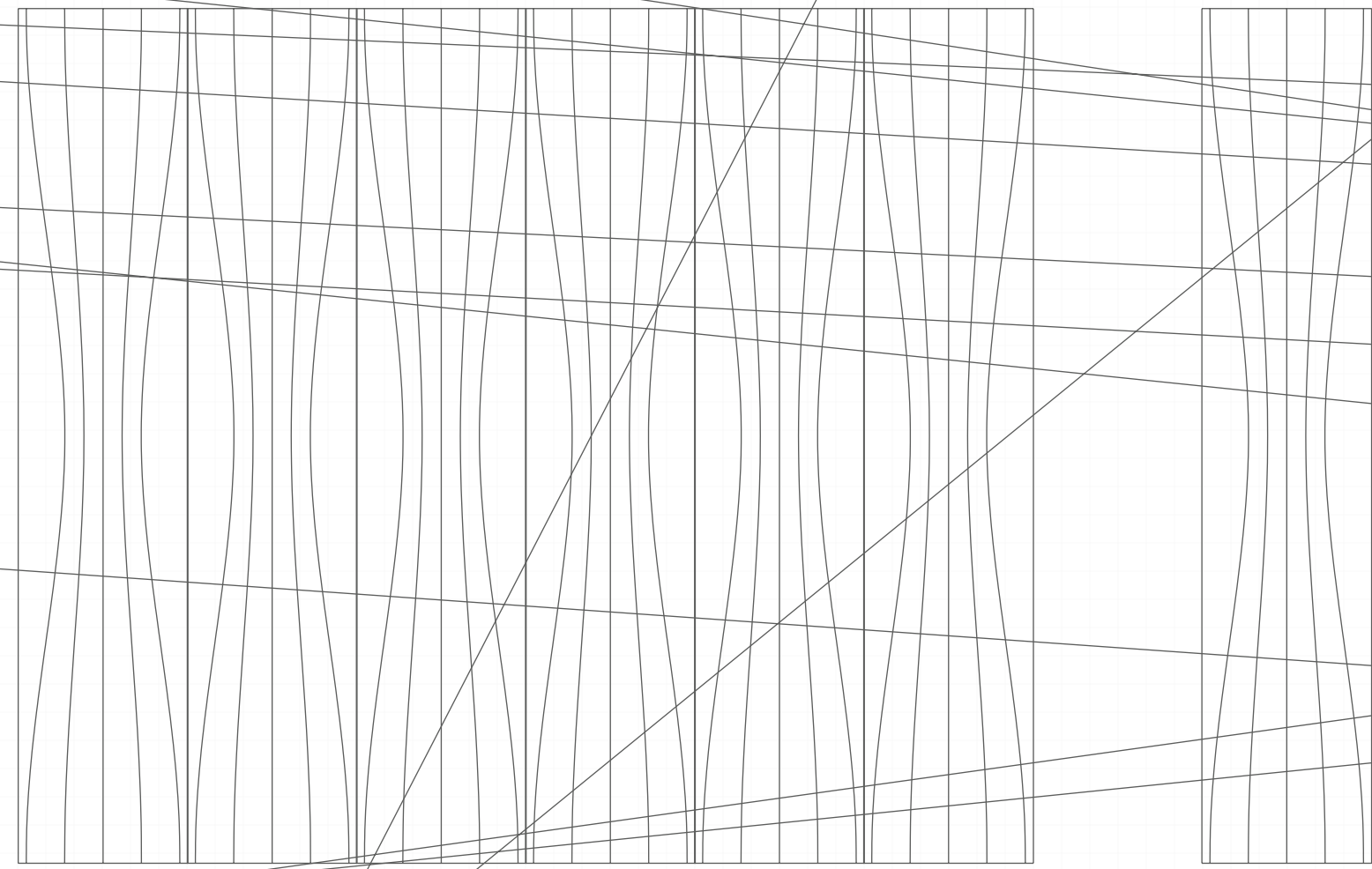

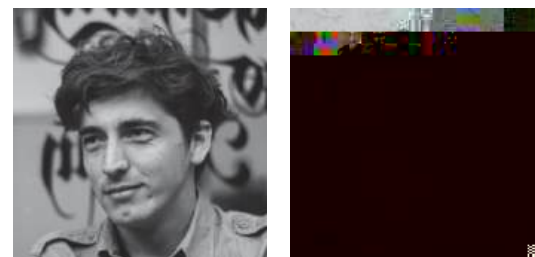

Designer: Diego and Leonardo (Argentina)

Squama, a nature-inspired biophilic designer wall panel, is crafted from premium Litheoz Concrete. This luxurious panel mimics organic patterns, bringing the tranquility of nature indoors.

Perfect for upscale interiors, Squama seamlessly blends durability with aesthetic elegance, transforming spaces into serene sanctuaries. Ideal for residential and commercial applications, Squama enhances any environment with its unique, eye-catching design, making it a sought-after choice for discerning designers and architects.

Perfect for upscale interiors, Squama seamlessly blends durability with aesthetic elegance, transforming spaces into serene sanctuaries. Ideal for residential and commercial applications, Squama enhances any environment with its unique, eye-catching design, making it a sought-after choice for discerning designers and architects.

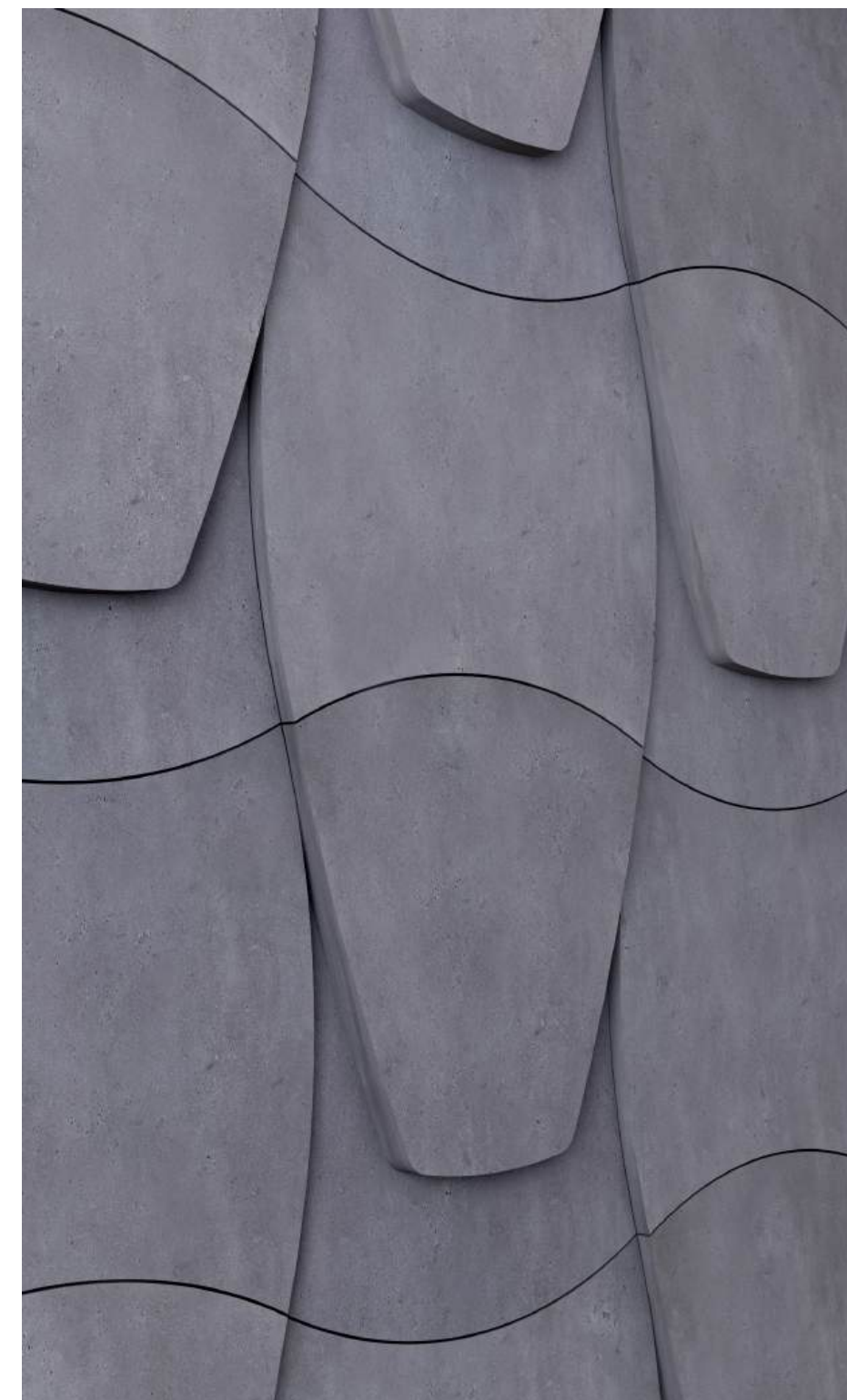

DIMENSIONS

MODULES

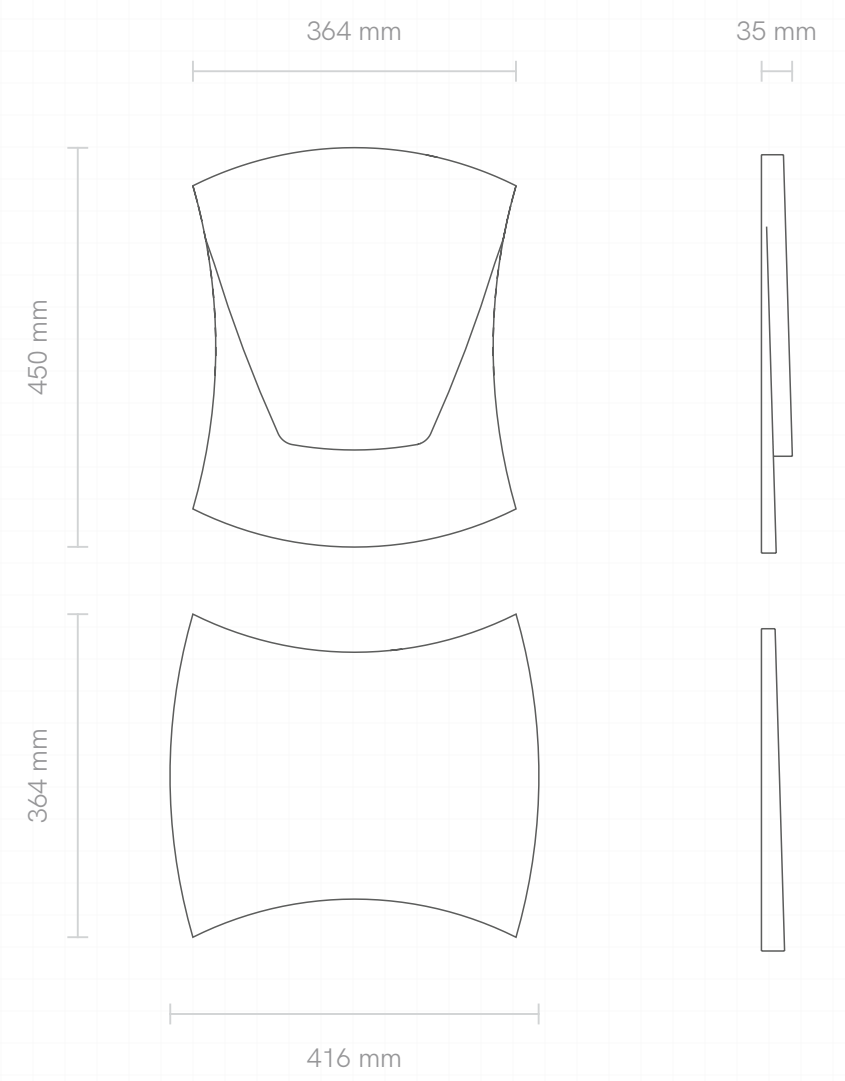

INSTALLATION PATTERNS

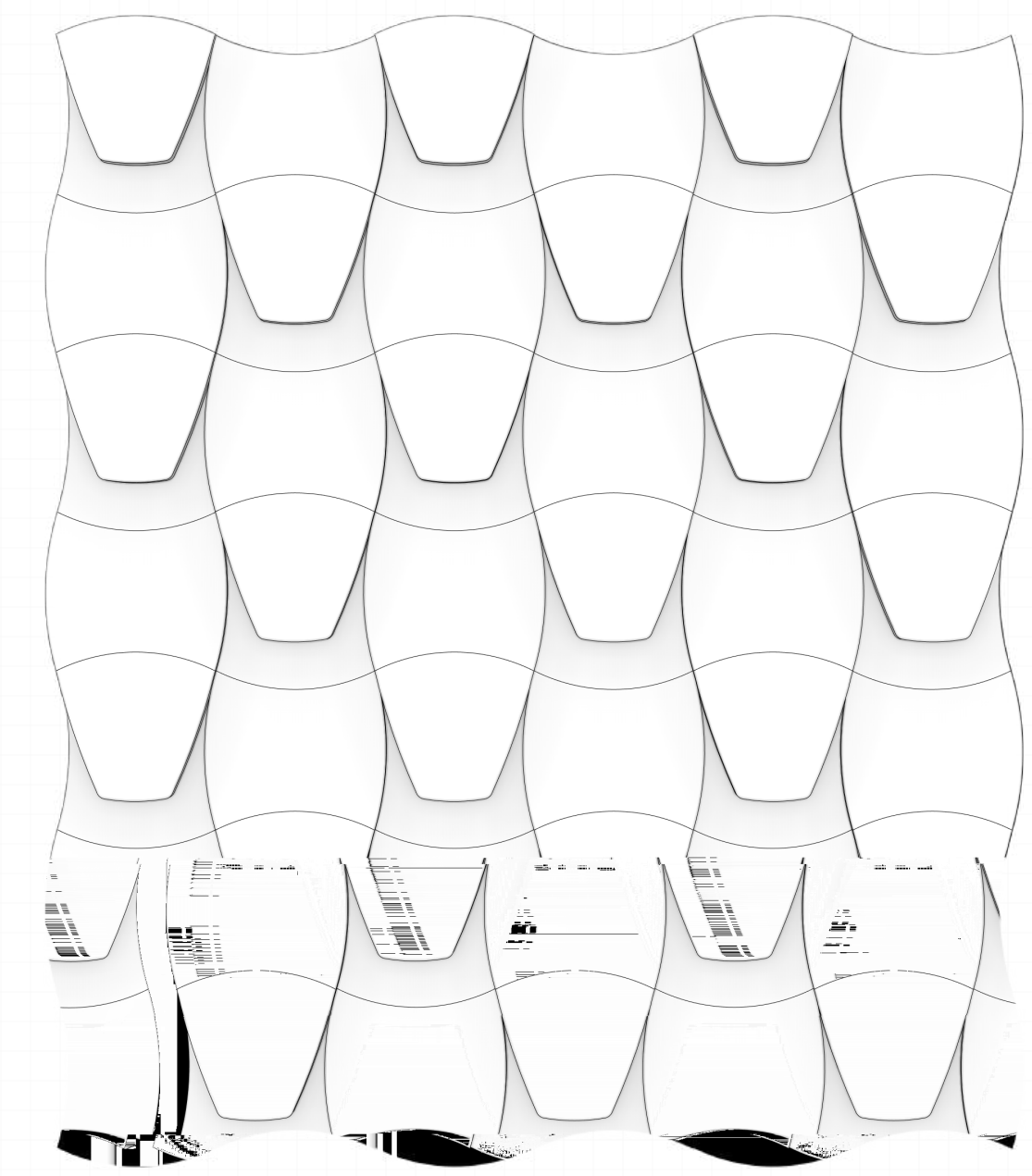

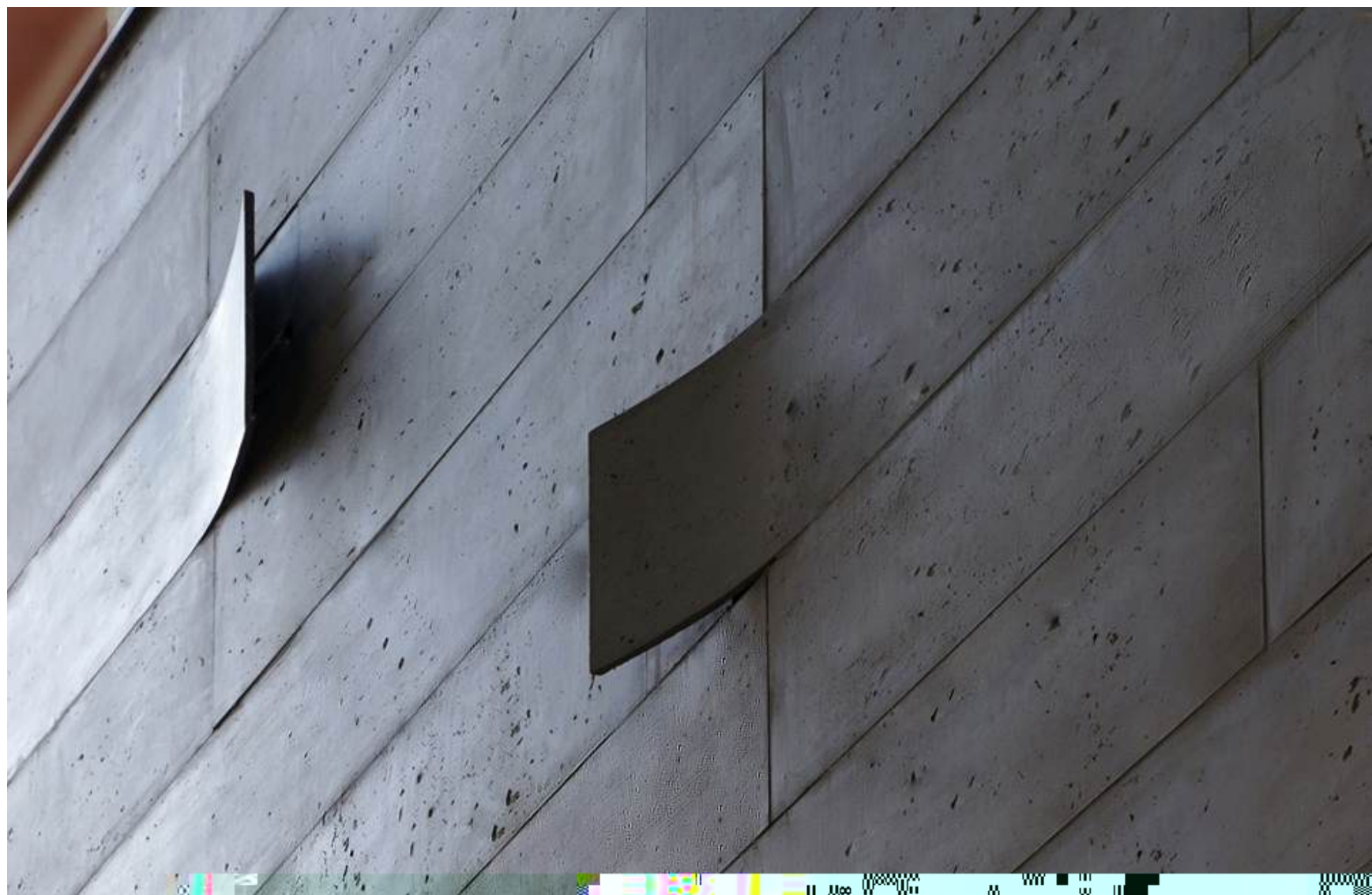

PEEL RT

Experience a wall that resonates with a peel-off effect with the Peel_Rt (Rectangle) wall panels. The design adds up a character to the walls embracing accent lighting. Achieve an ideally premium look with the smooth bend and finesse of the Peel_Rt handcrafted by Nuance Artisans.

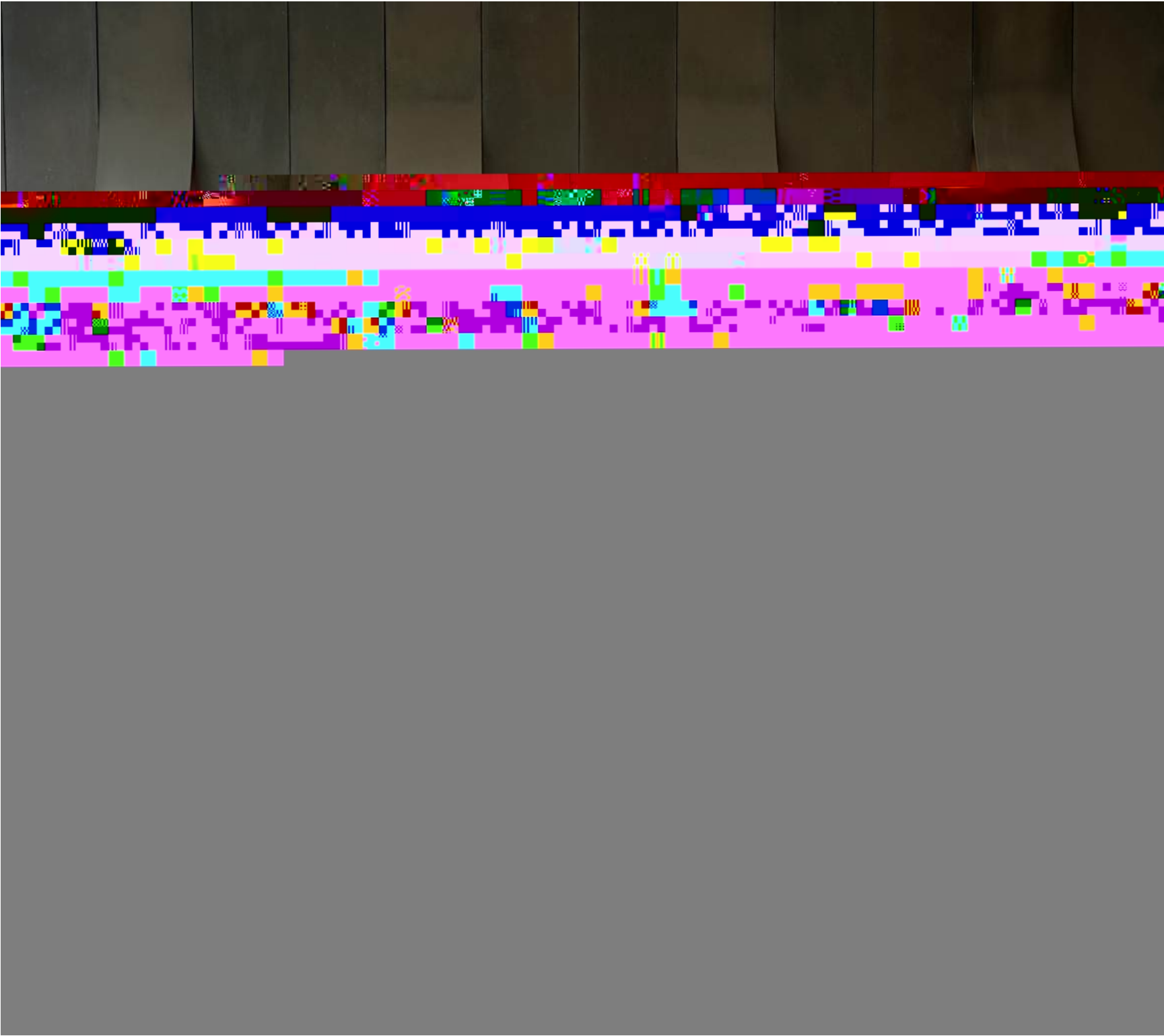

DIMENSIONS

MODULES

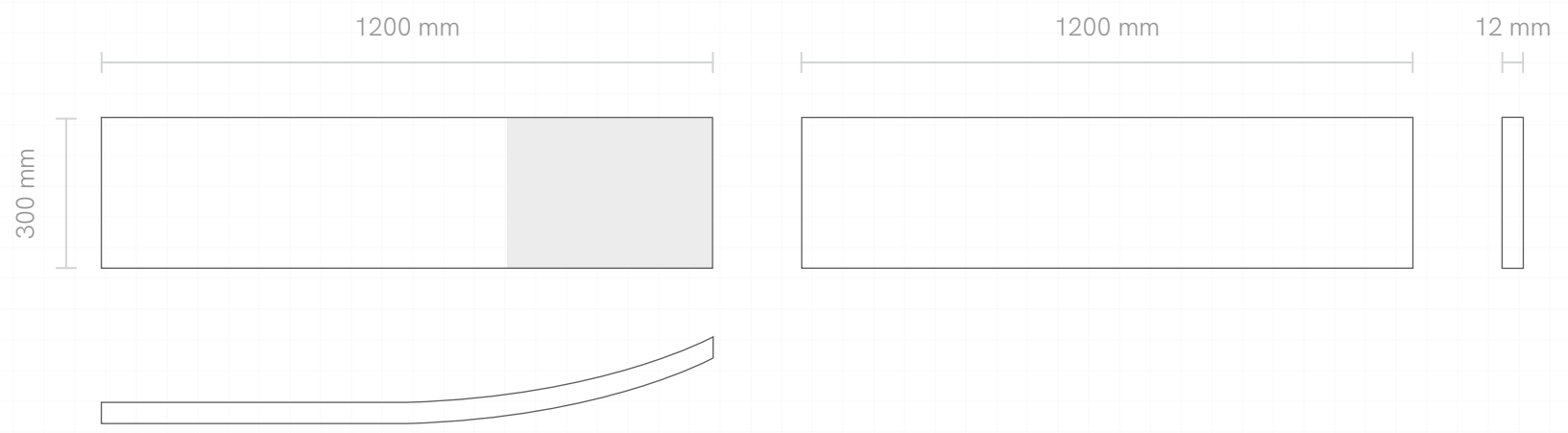

INSTALLATION PATTERNS

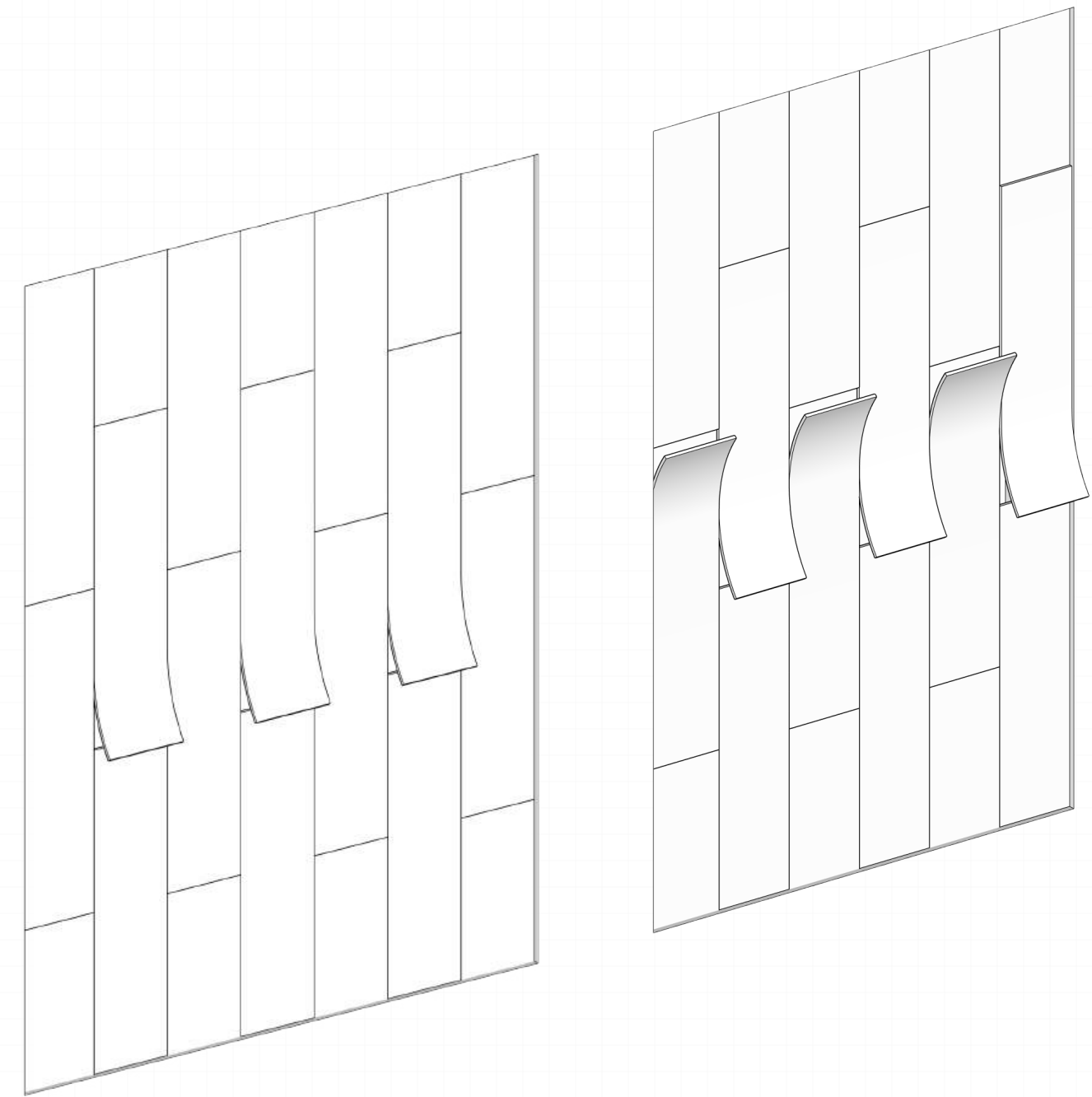

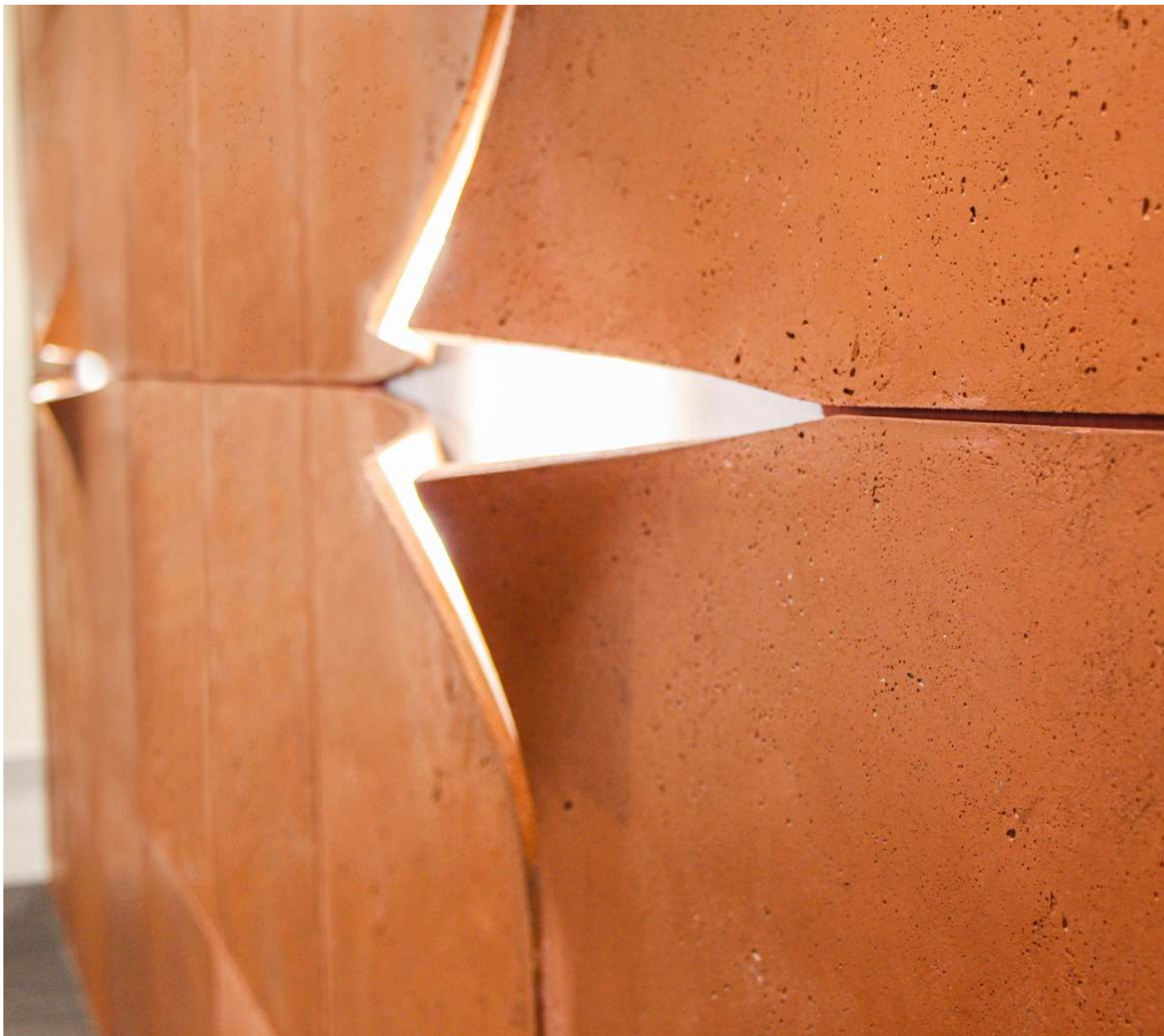

PEEL SQ

Shapes and size variations are important for your indoors to develop a premium look and feel. Embrace Peel_Sq (Square) wall panels crafted with ultimate artistry and perfection to ensure a quality finesse like never before.

DIMENSIONS

MODULES

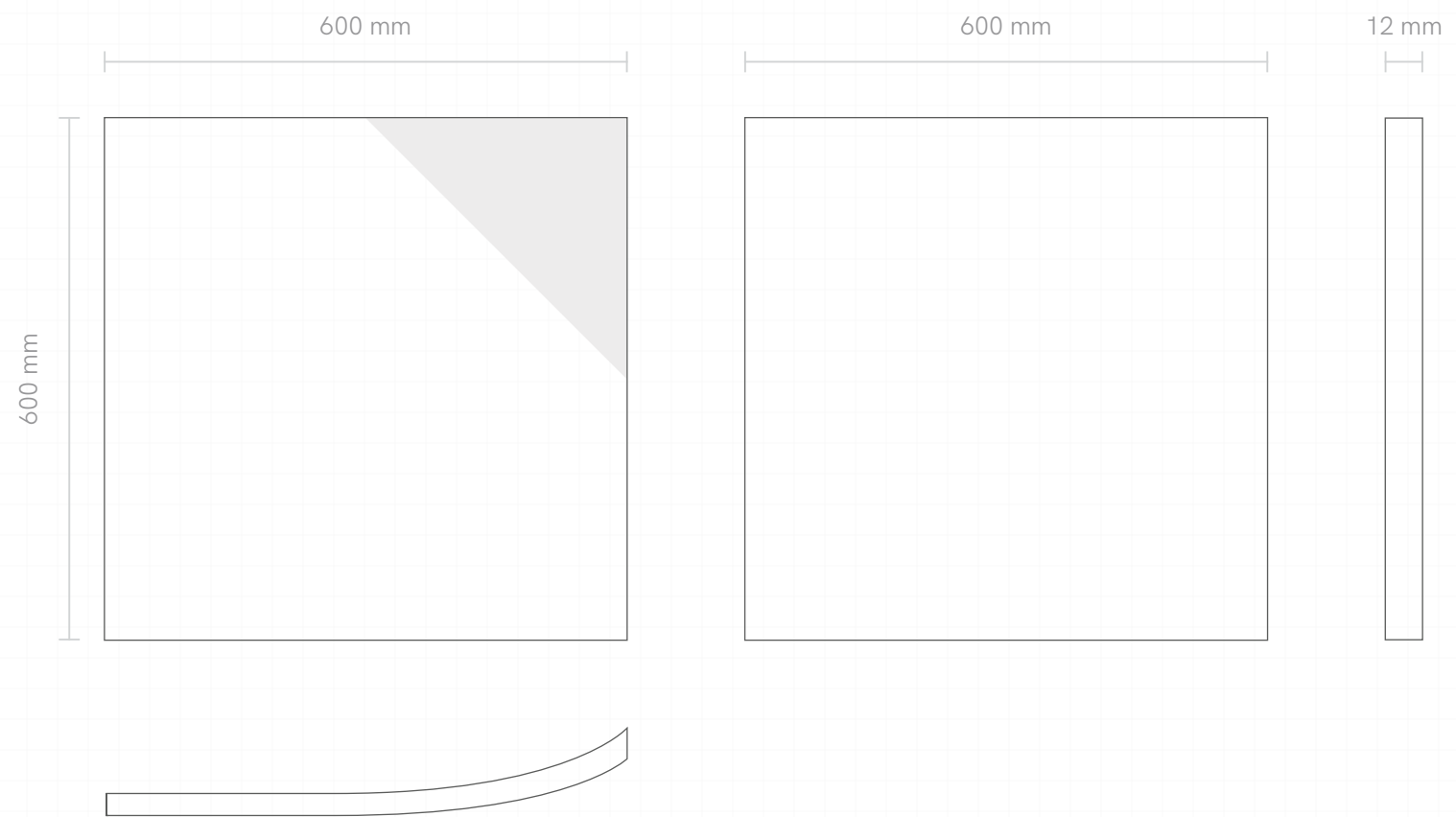

INSTALLATION PATTERNS

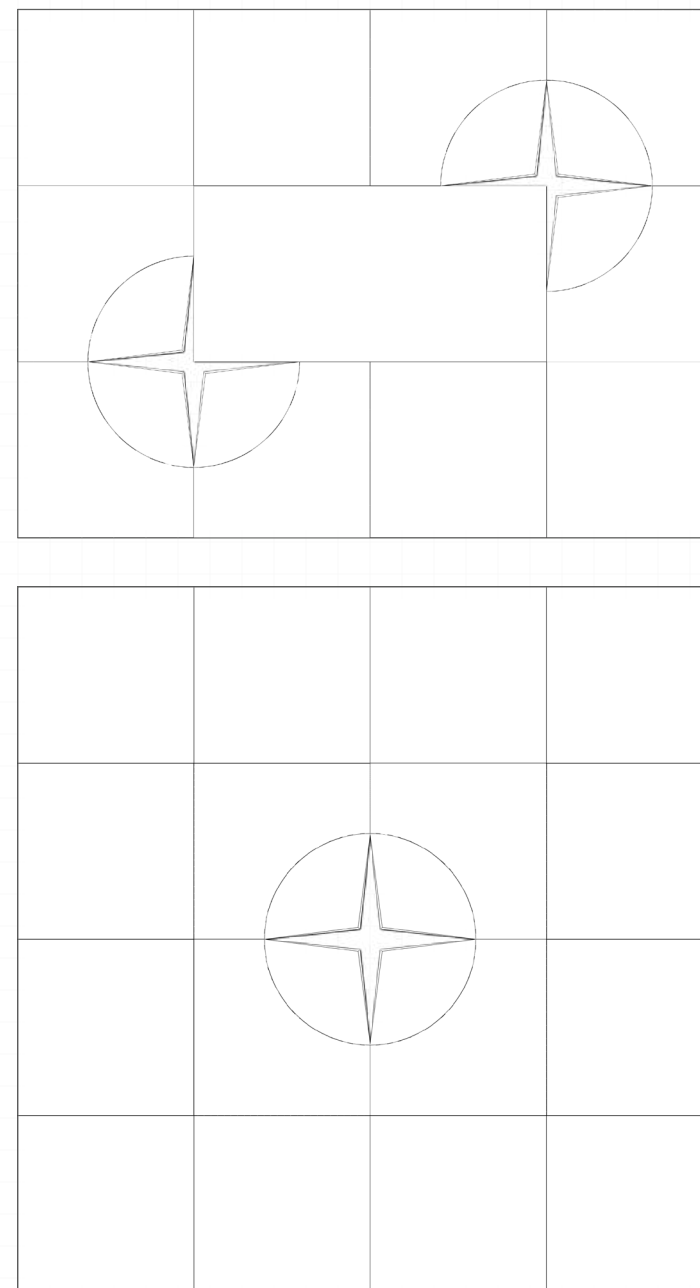

BENDT HUMPH

Elevate walls with the smooth waves formed by the Hump wall panels by Nuance Studio. Allow your space to add an ambient inspiration from nature itself, as the finesse of Hump wall panels change the ordinary walls to luxurious extravaganza.

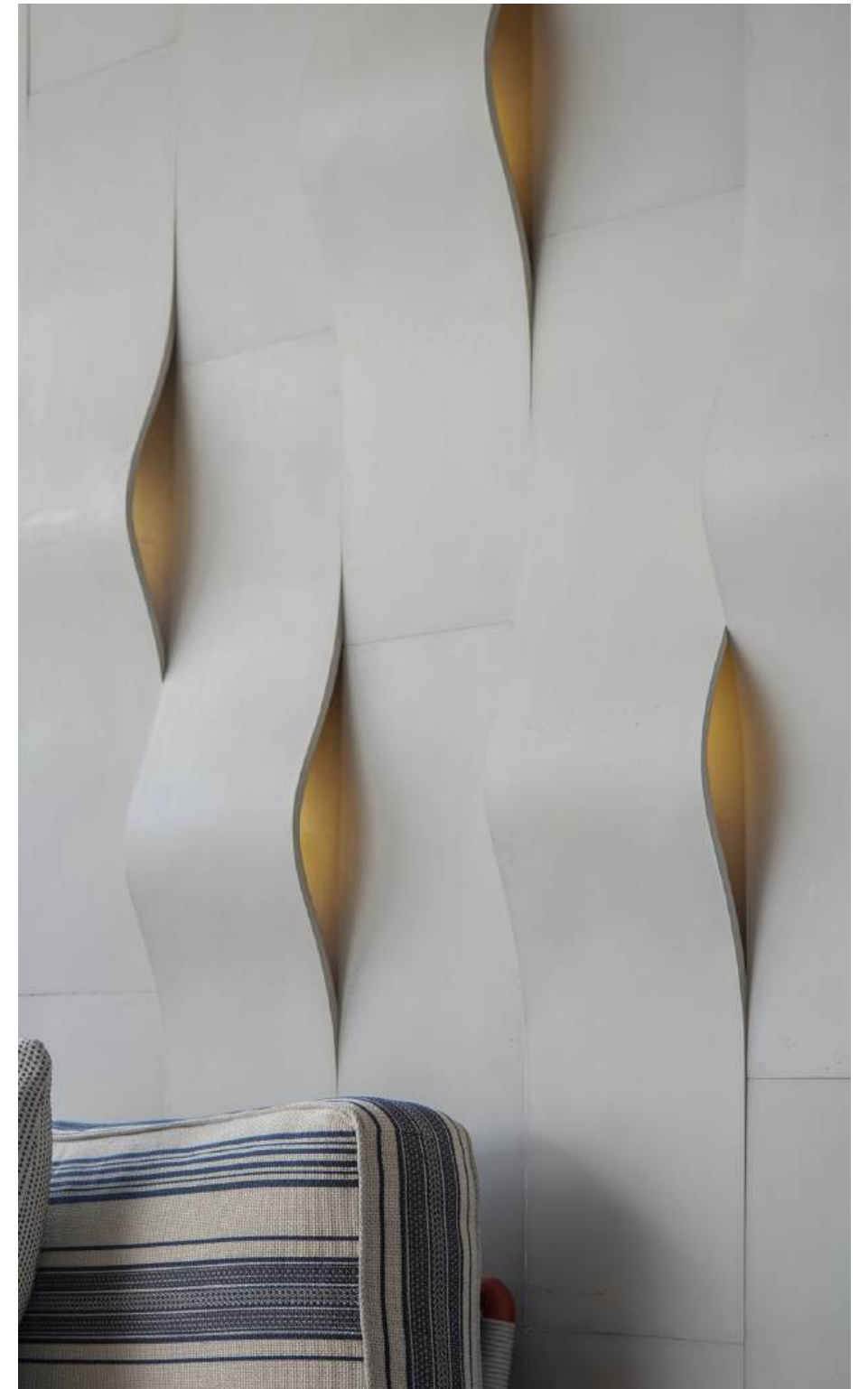

DIMENSIONS

MODULES

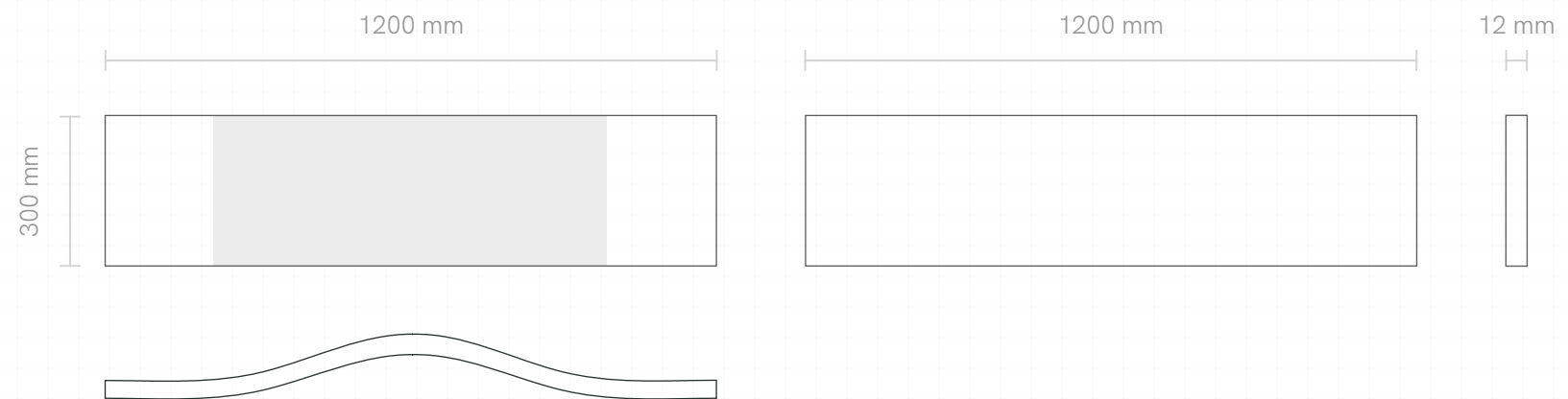

INSTALLATION PATTERNS

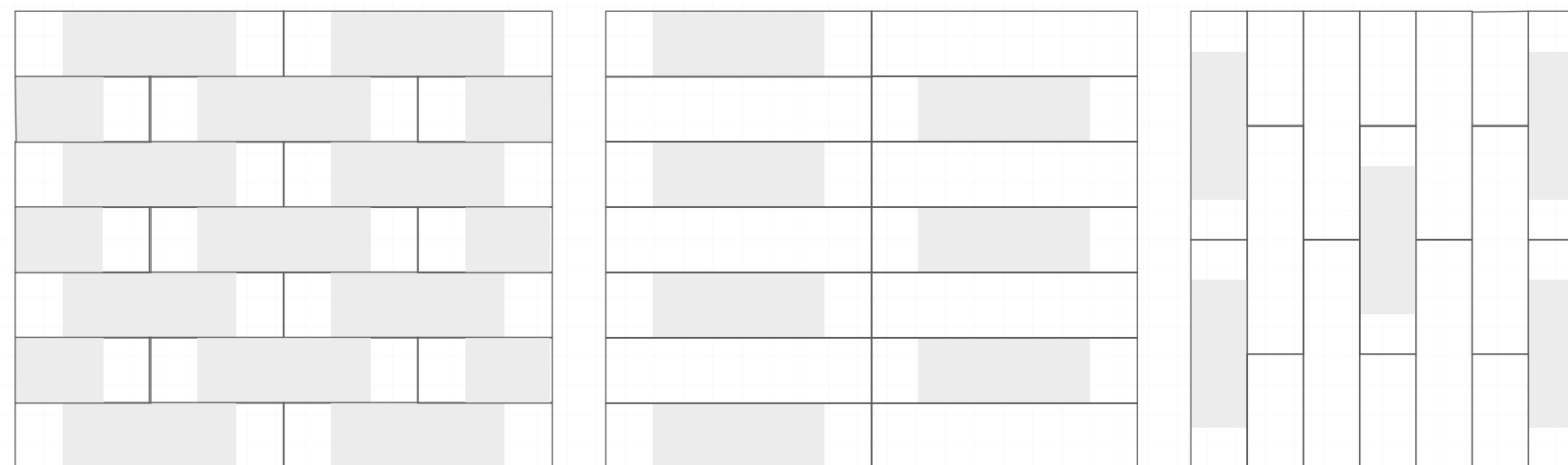

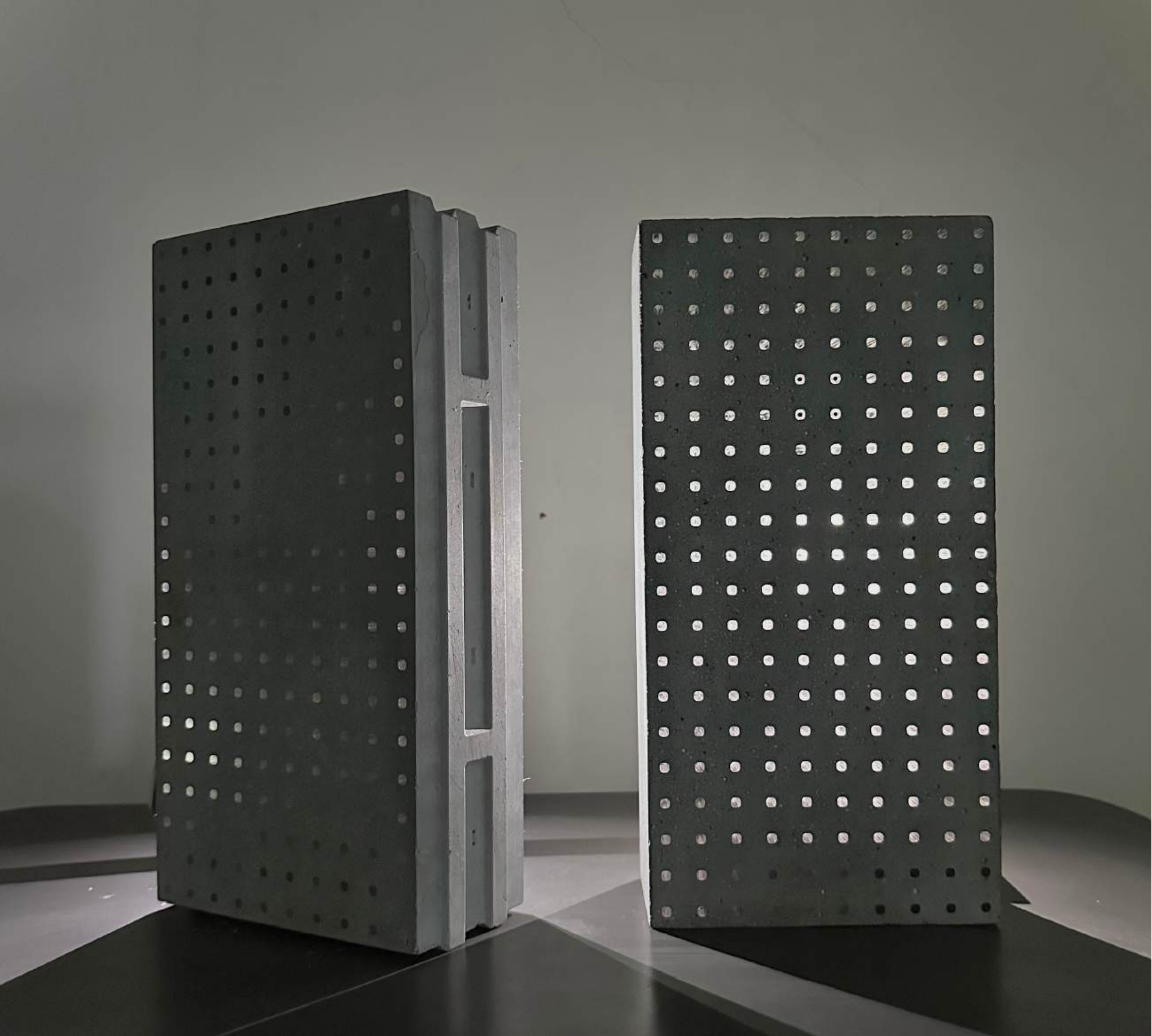

TRANSLUMIERE BRICKS

At first glance, one might not immediately grasp the artistry within. As natural light dances through the seamless, transparent patterns, the brilliance of these concrete marvels becomes undeniable. Throughout the day, the sun's journey casts ever-changing shadows, narrating a story of light and movement. By night, the embedded lights shimmer like precious jewels, transforming any space into a haven of sophistication.

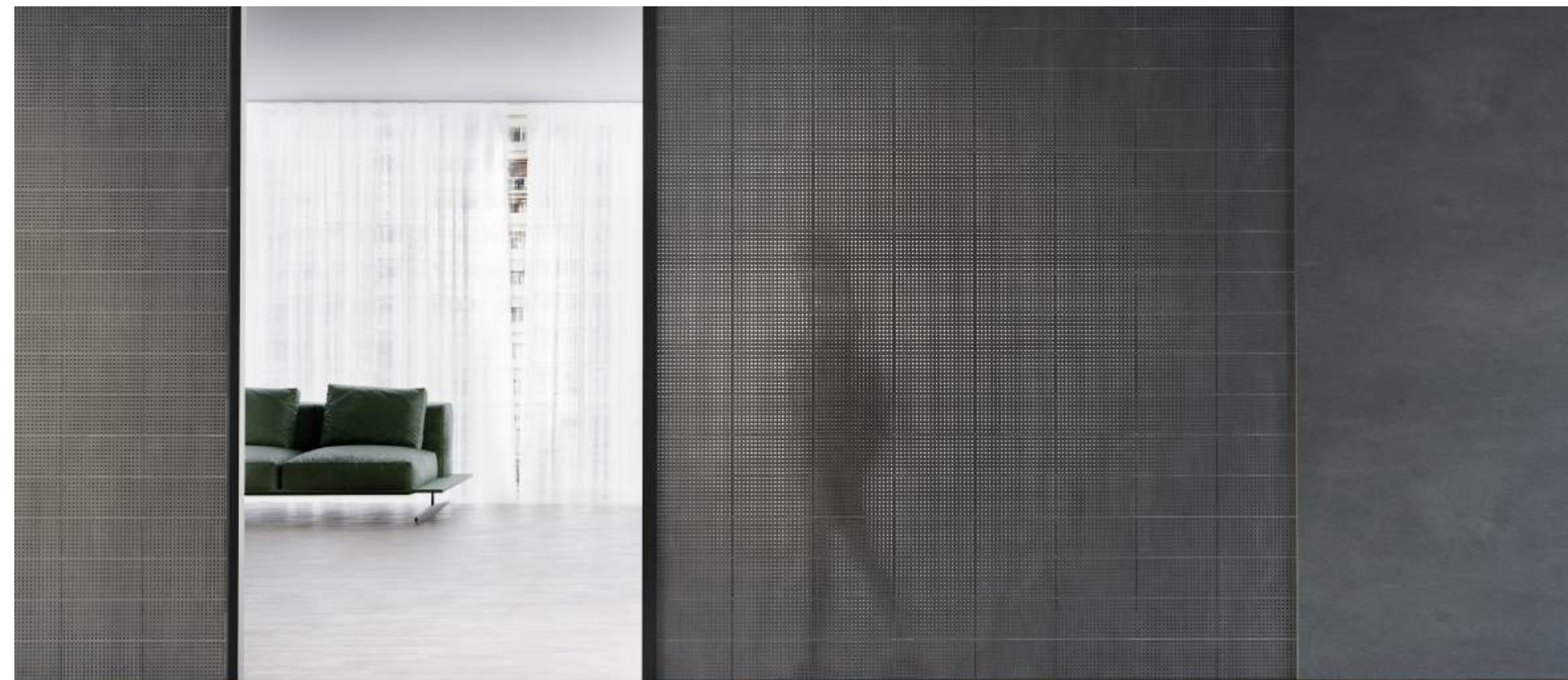

DIMENSIONS

MODULES

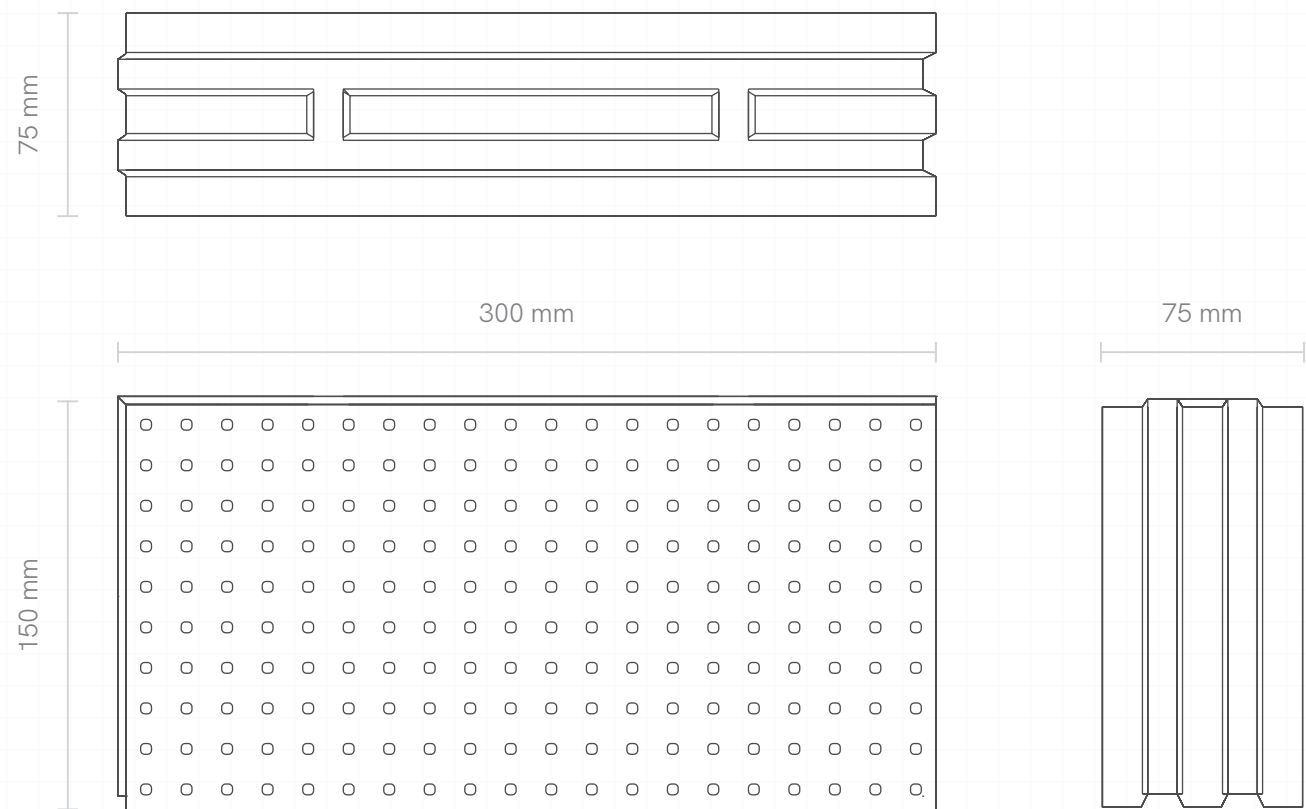

INSTALLATION PATTERNS

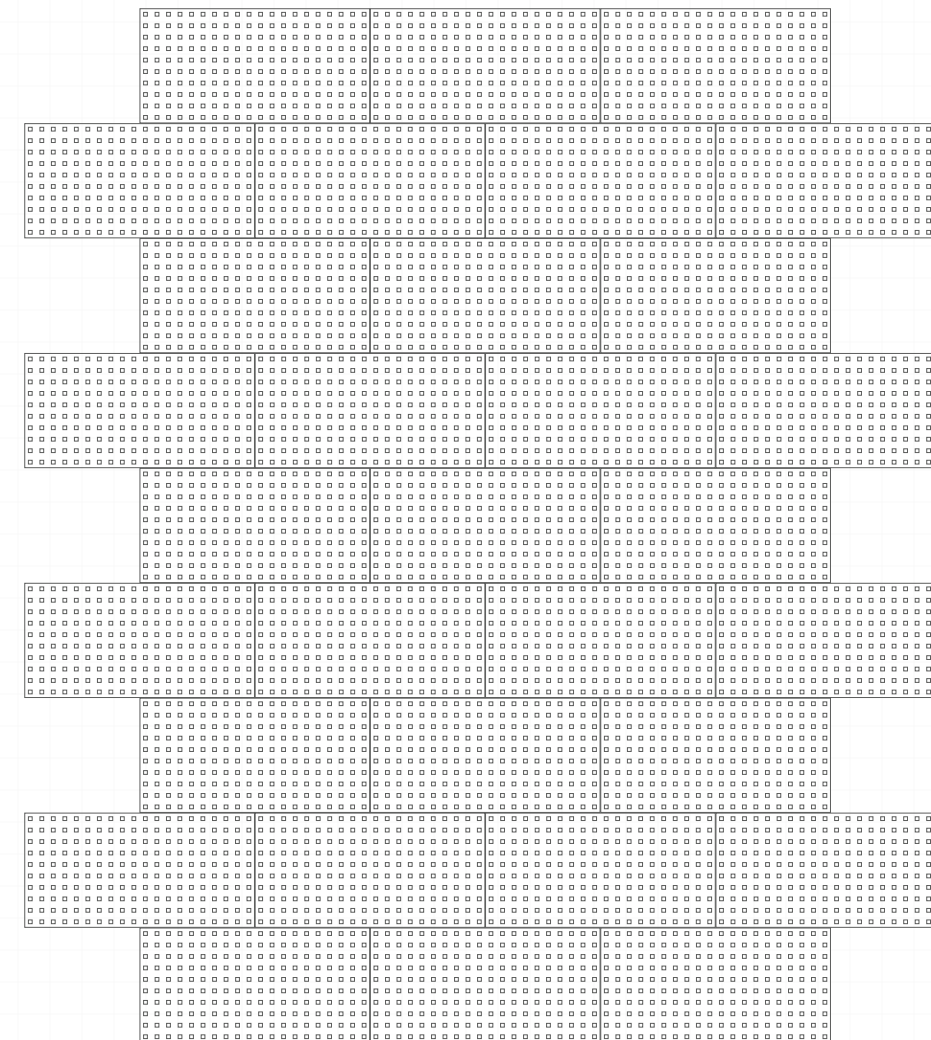
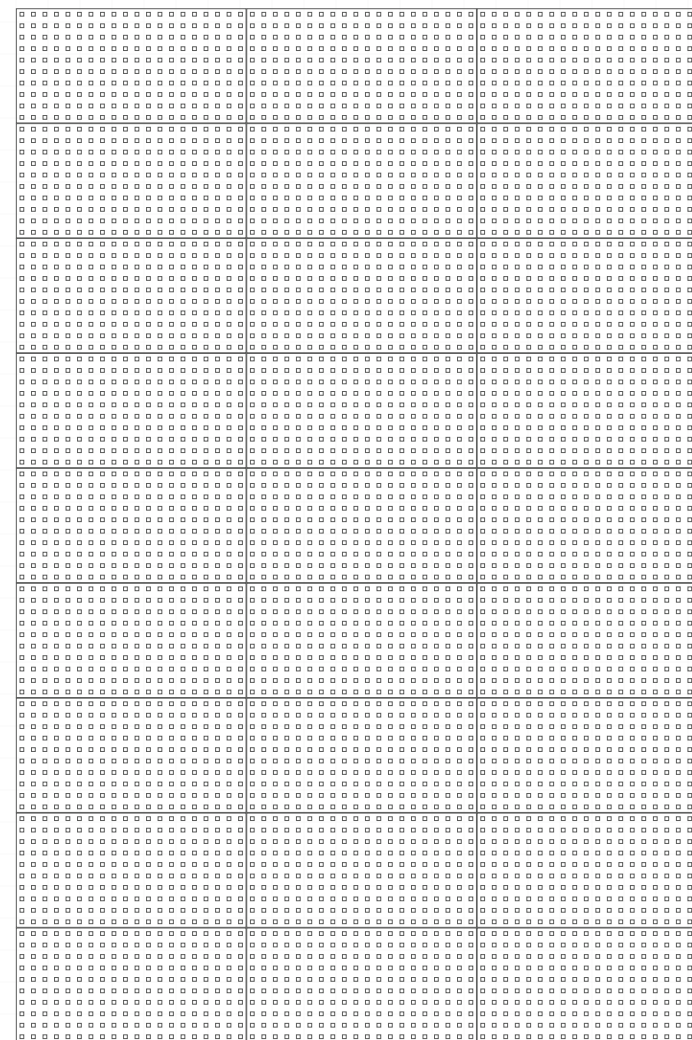

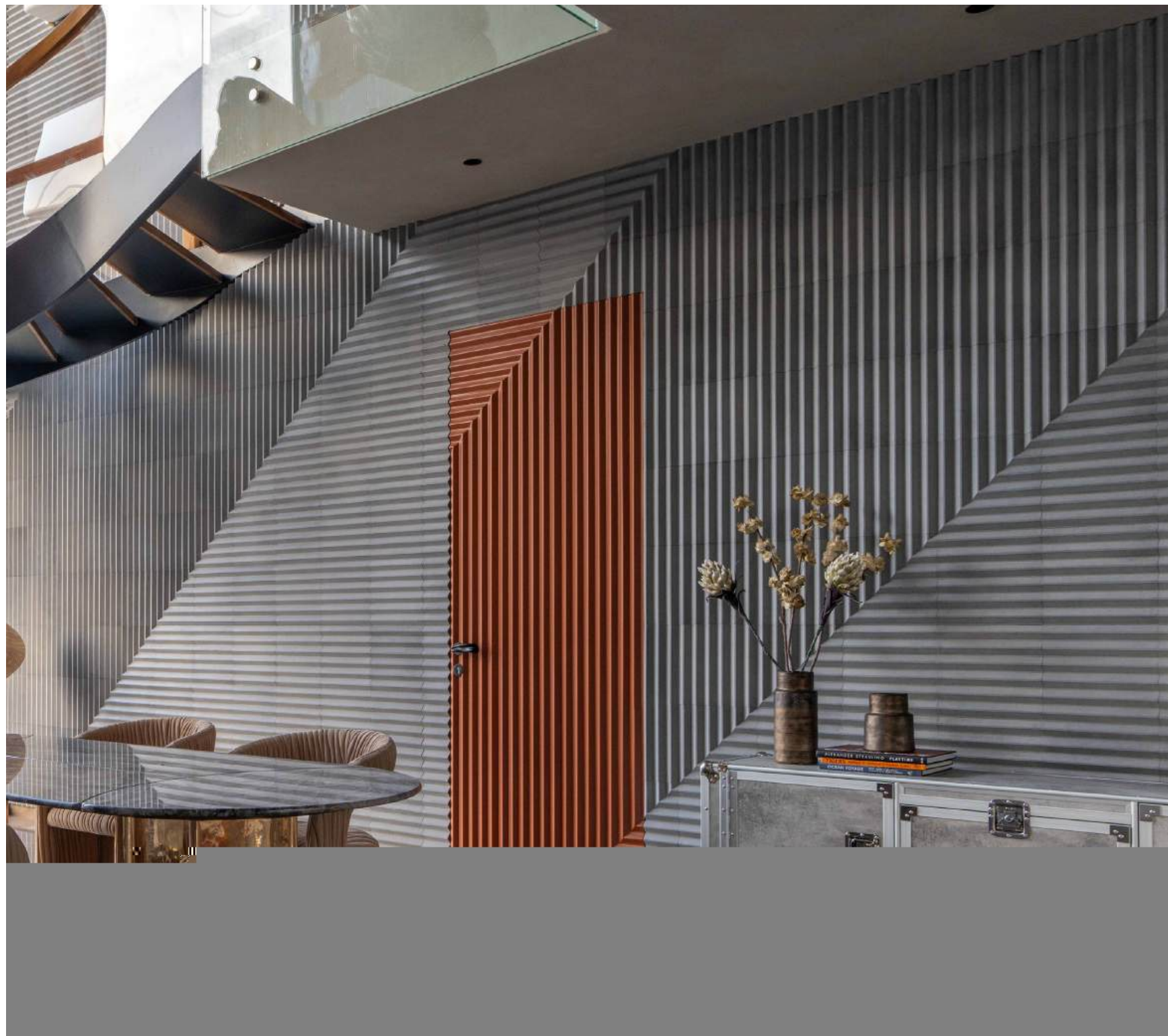

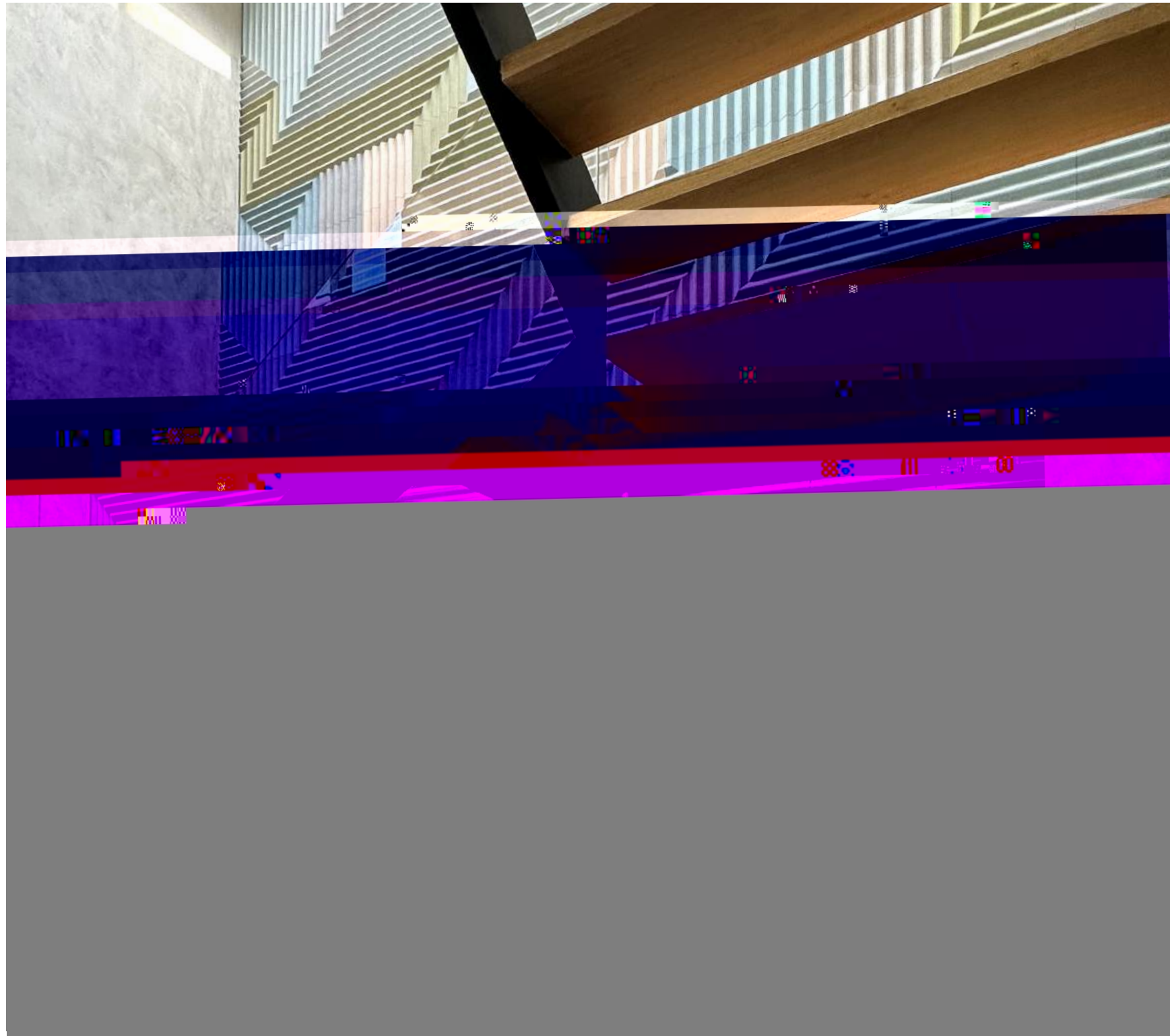

DIMENSIONS

MODULES

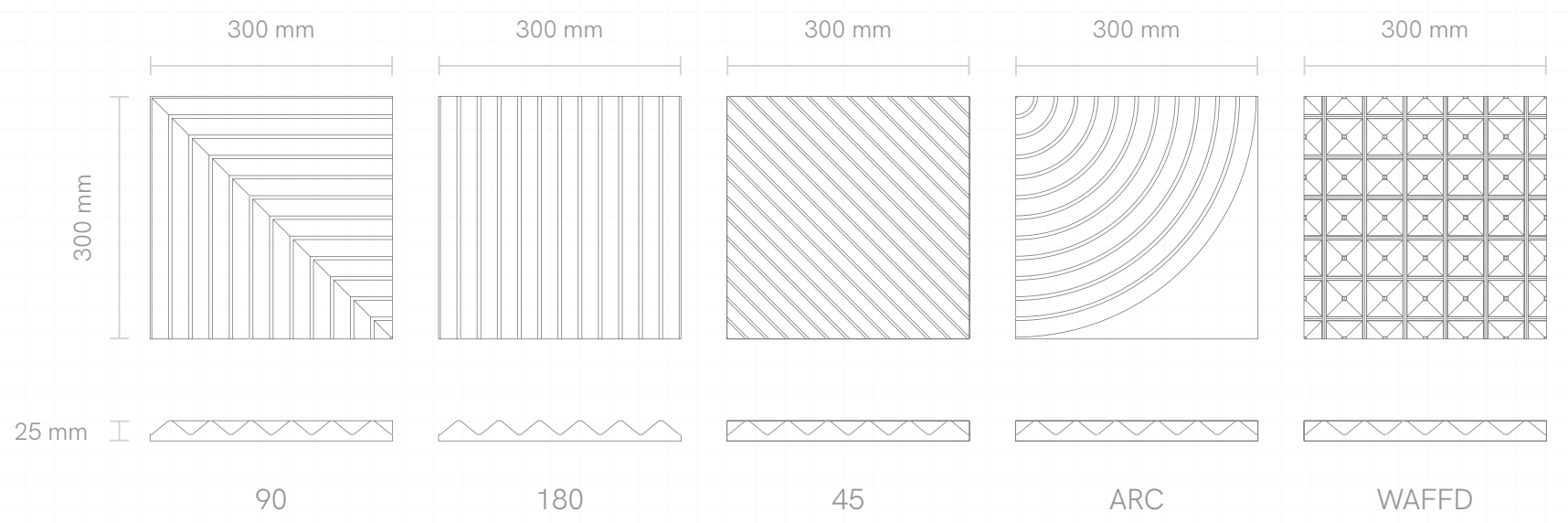

INSTALLATION PATTERNS

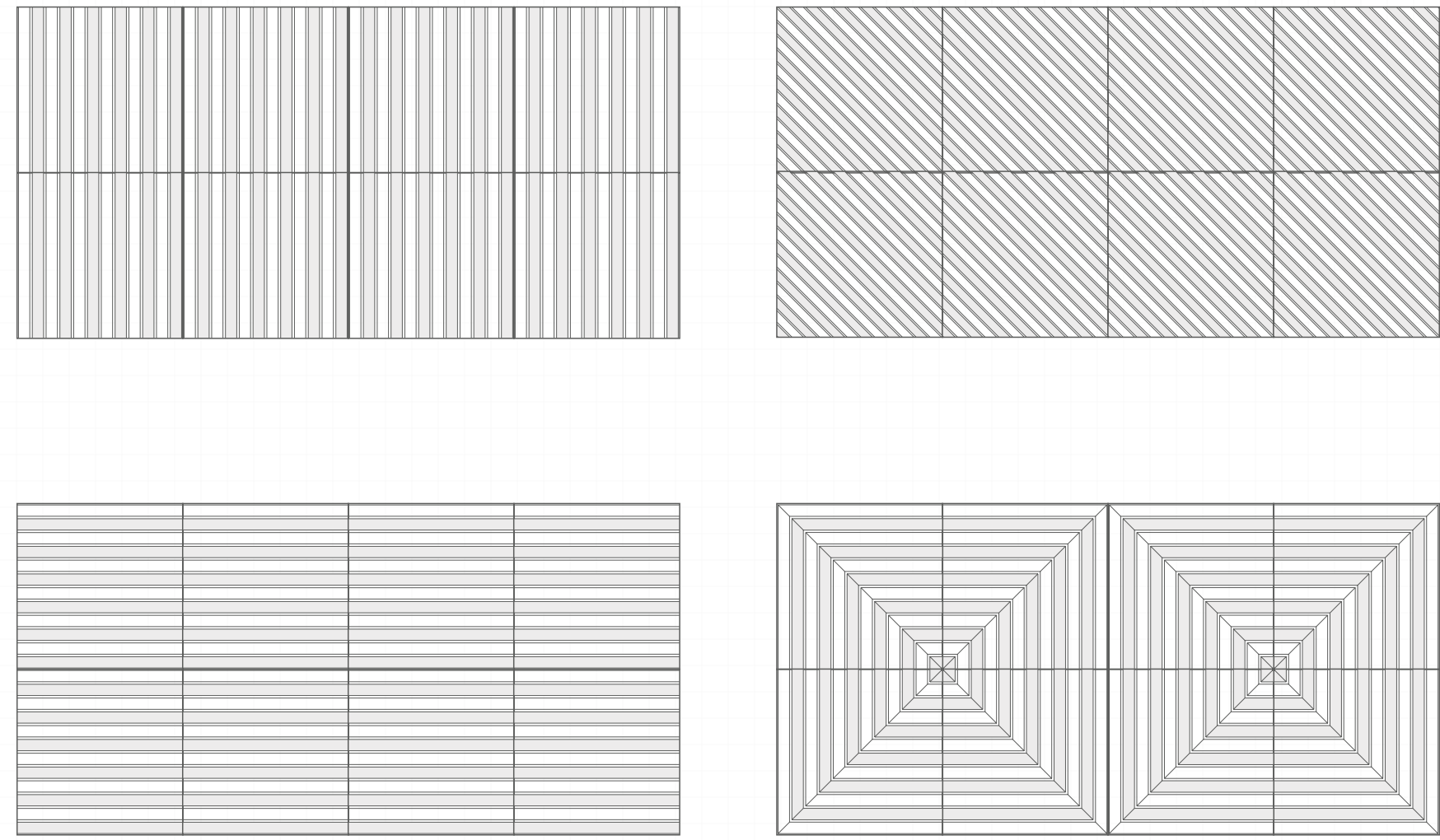

DIMENSIONS

INSTALLATION PATTERNS

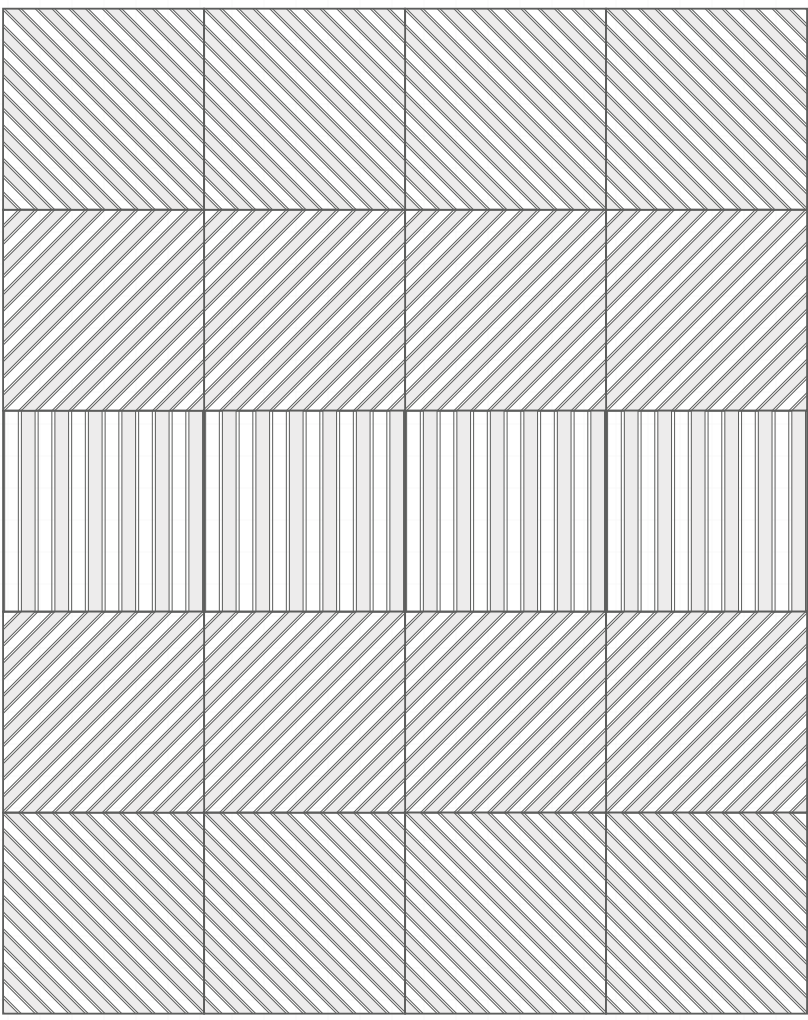
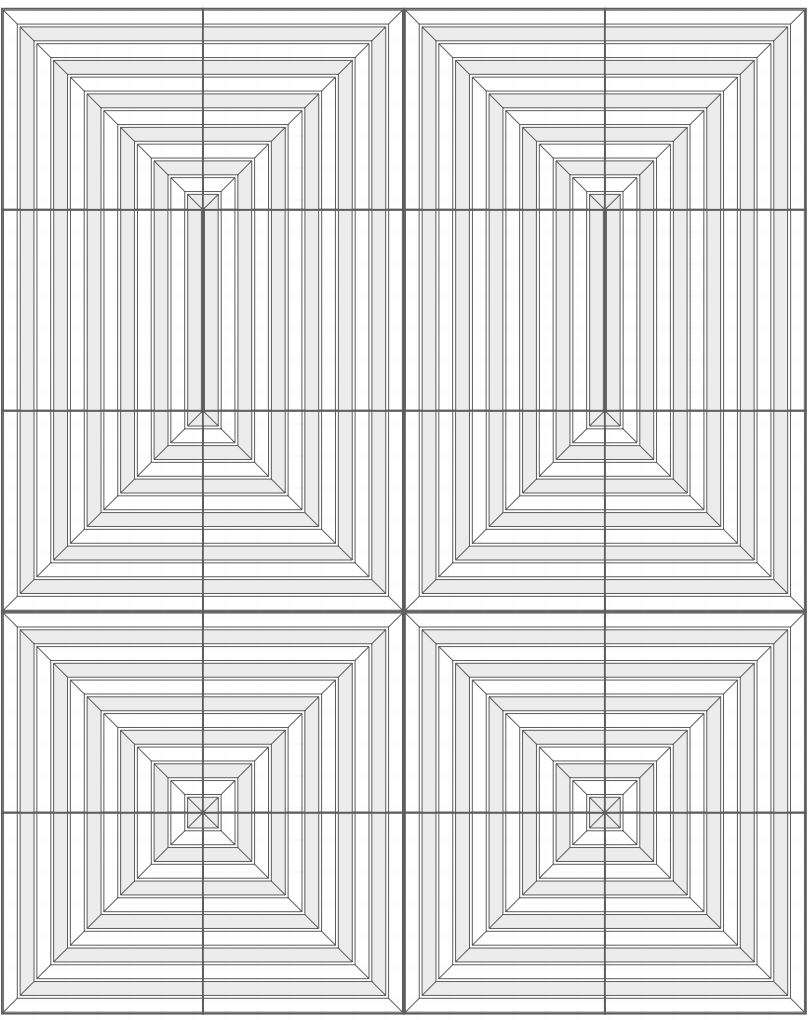

INSTALLATION PATTERNS

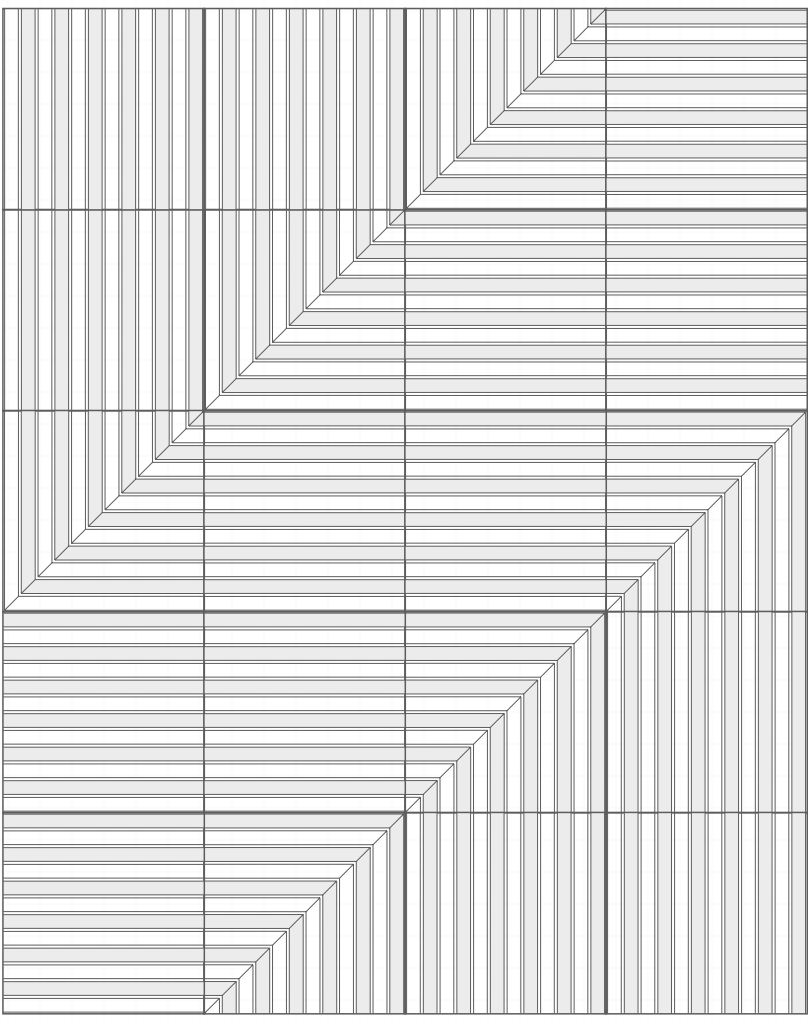
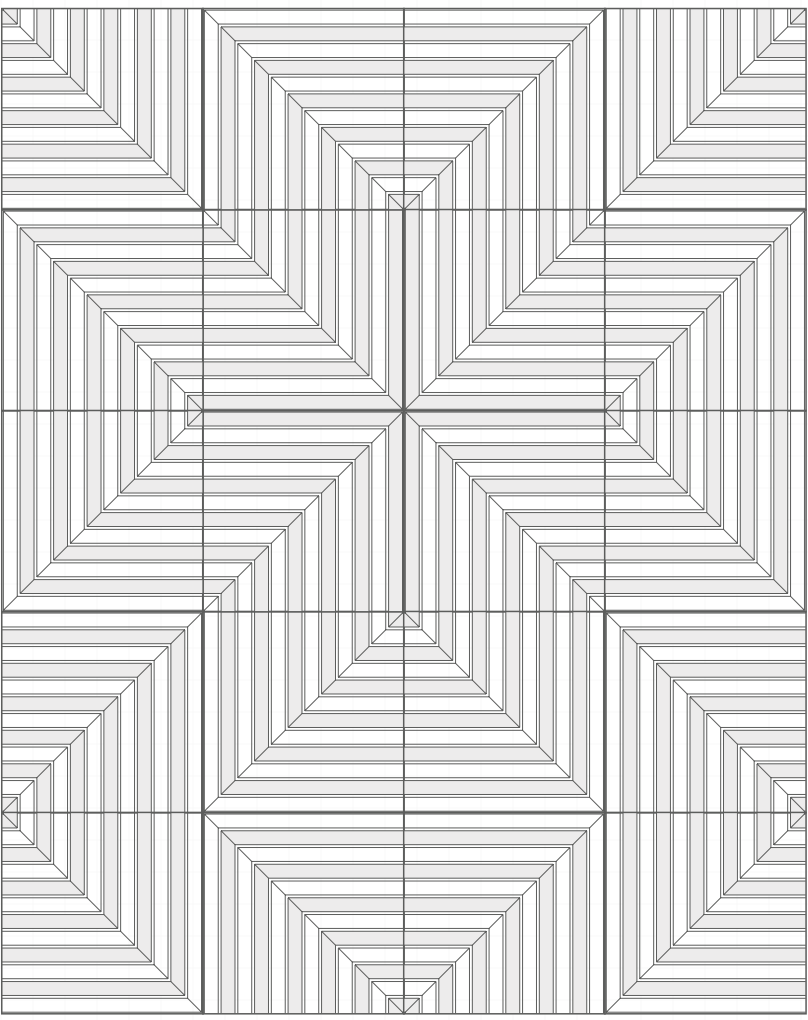



MEGAHOUND

Megahound elevates this historic design to new heights with an oversized houndstooth pattern that offers a striking three-dimensional perspective. The interplay of contrasting colors beautifully manipulates light, creating a dynamic visual experience that is as captivating as it is sophisticated.

For those driven by a passion for creating timeless designs, it is only fitting to draw inspiration from history's most iconic patterns. Introducing Megahound by Nuance Studio, where the classic houndstooth motif is reimagined into a contemporary masterpiece. Originating thousands of years ago, the houndstooth pattern has captivated generations with its unique, abstract check design and enduring elegance.





DIMENSIONS

MODULES

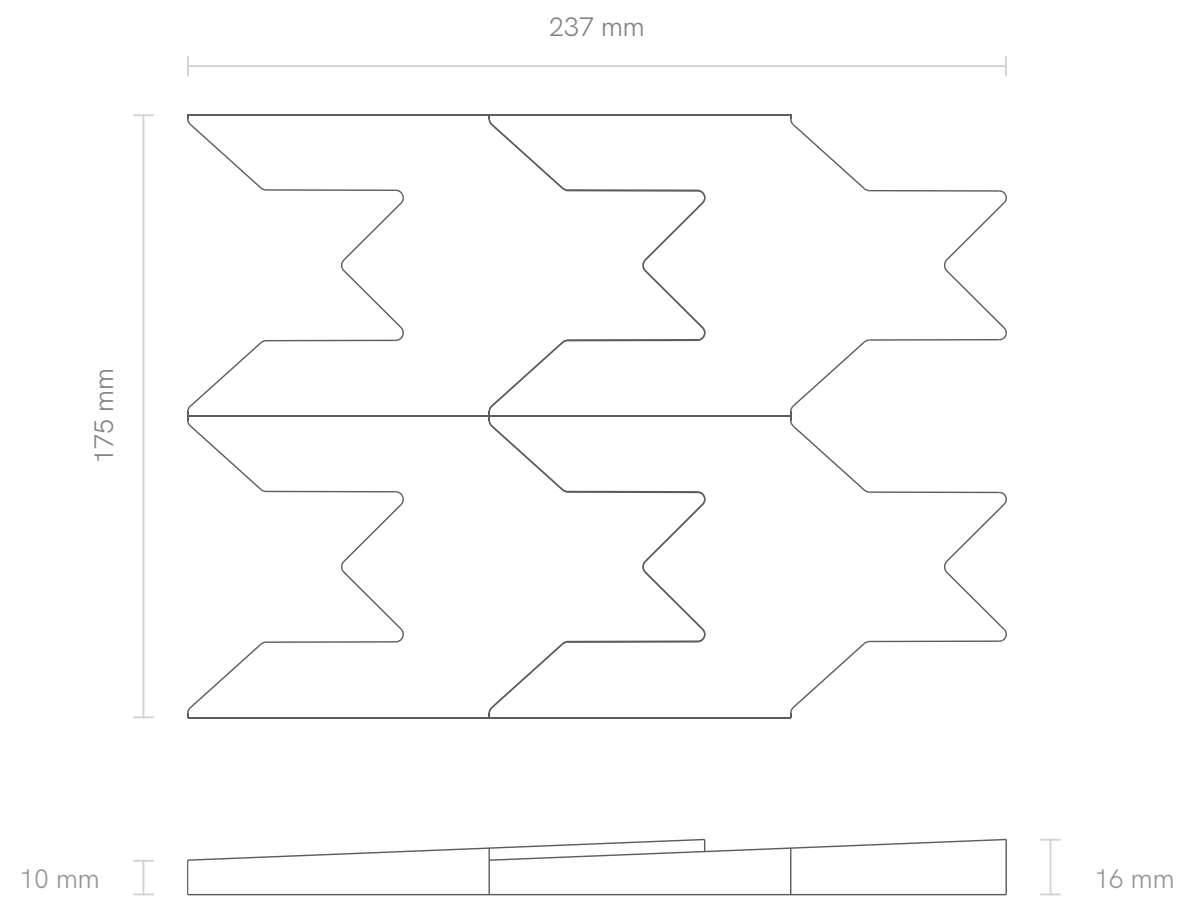

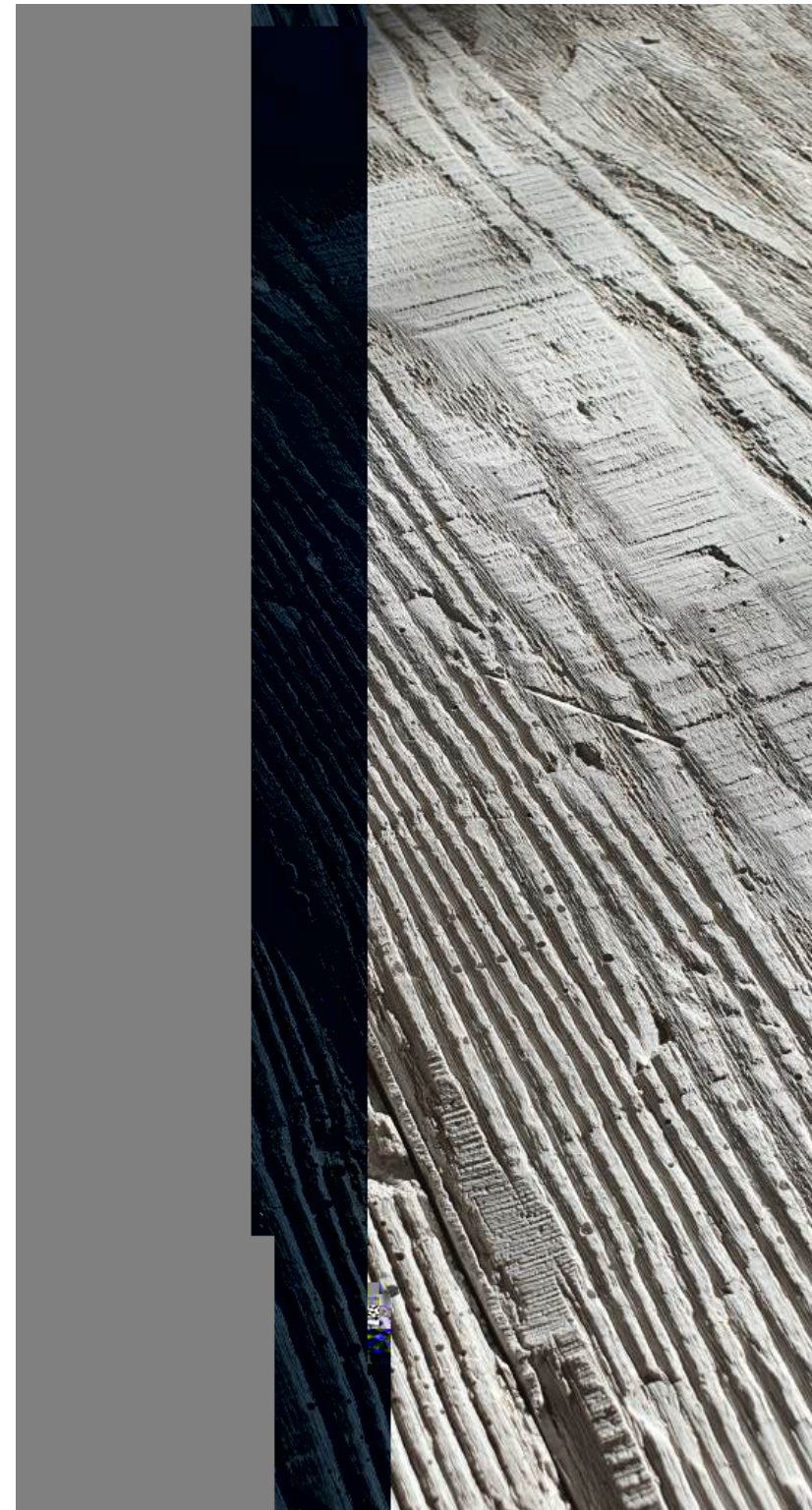

WOODEN SLATS

Indulge in the allure of Fibonacci Series by Nuance Studio, where each installation transcends mere functionality to become a symphony of visual delight. Derived from the revered Fibonacci principle, each panel's width embodies timeless perfection, lending a touch of divine proportion to your surroundings.

Experience the perfect blend of form and function with the Fibonacci Series, where every installation is a testament to luxury and refined taste.





DIMENSIONS

MODULES

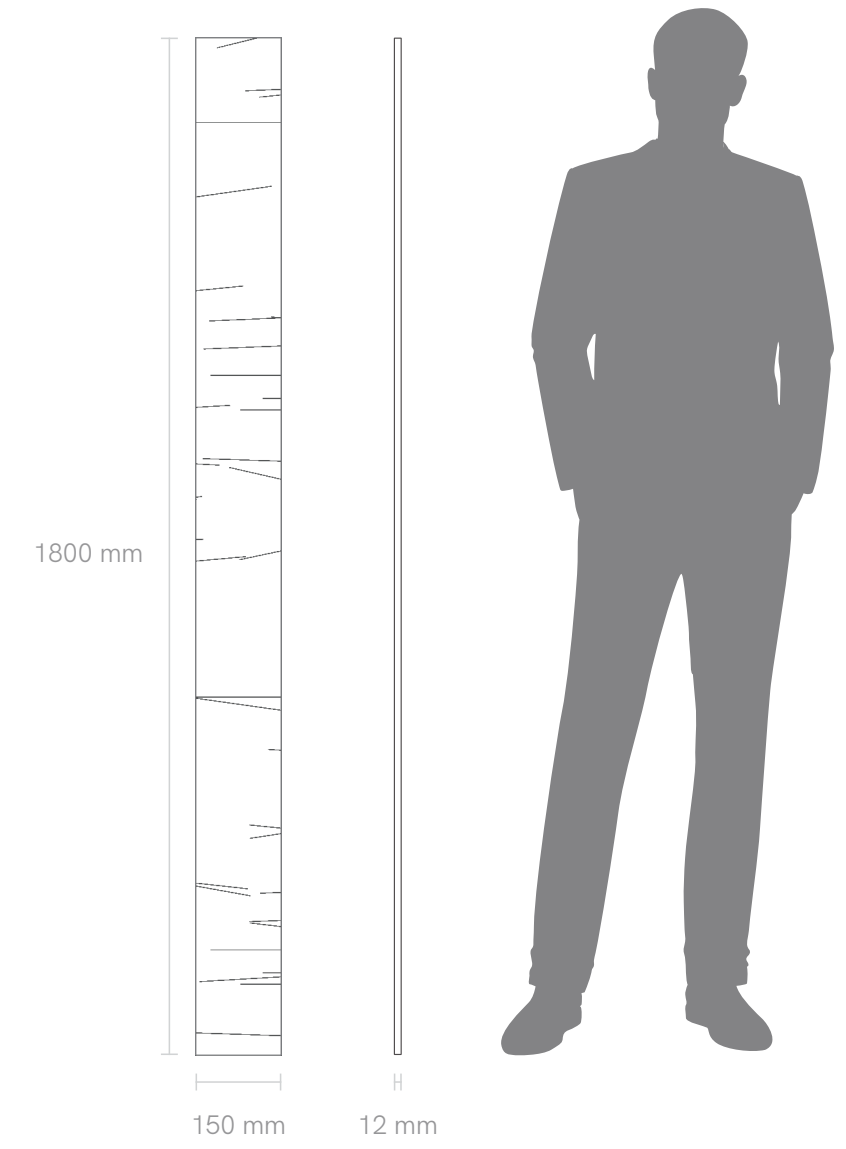

FLUTED SERIES

Step into a realm where concrete transcends its conventional boundaries, emerging as a symbol of opulence and sophistication. Each panel in our Designer Series is a masterpiece of design ingenuity, meticulously curated to exude an aura of exclusivity and prestige.

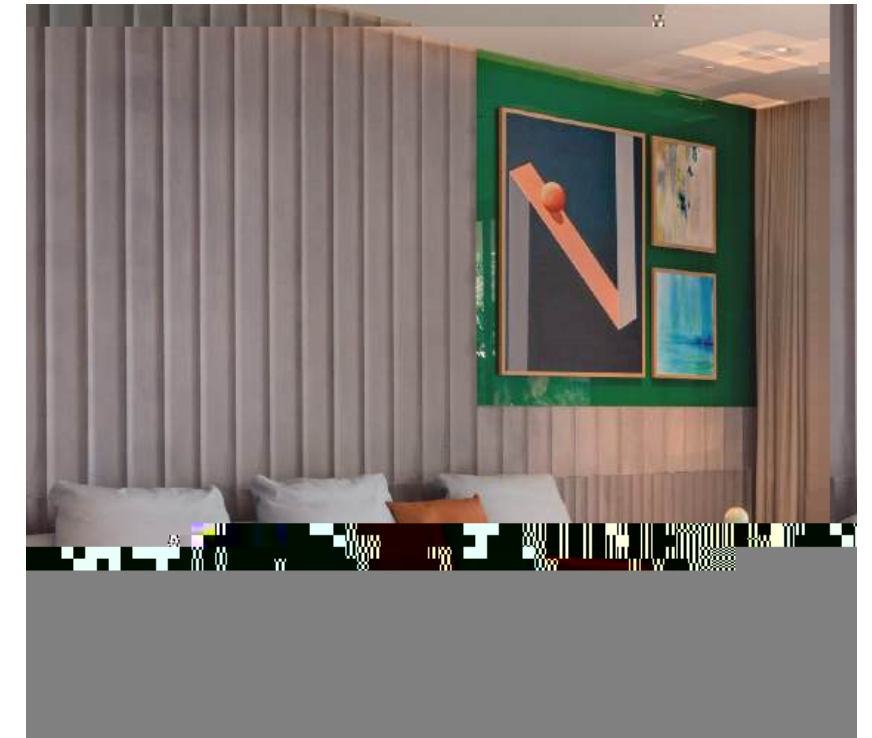
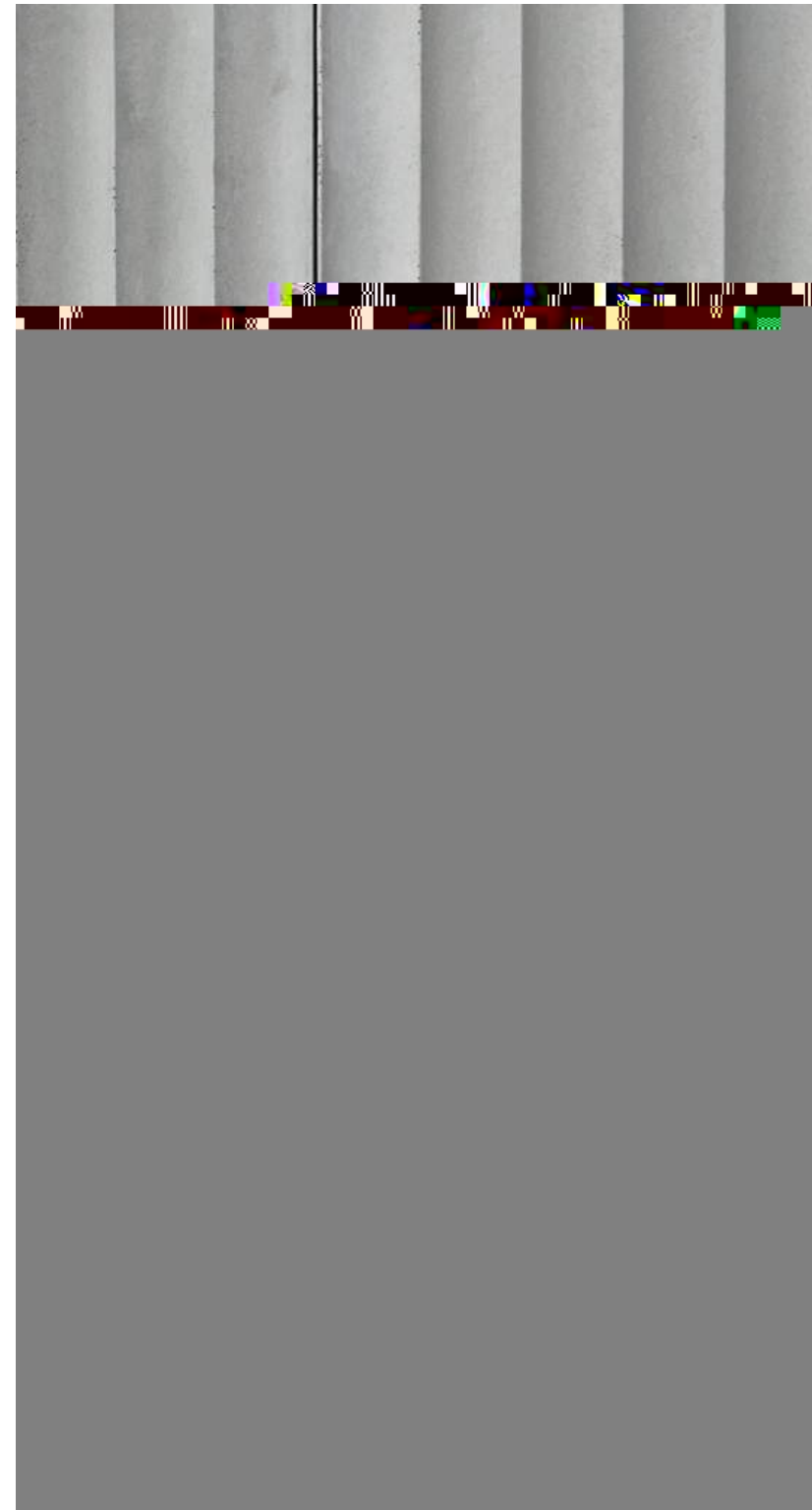

DORIC

Elevate your space with the Doric Series, a masterpiece inspired by the classical Greek design language. Crafted to embody the essence of noble sobriety and primitive simplicity, these panels pay homage to the distinctive characteristics of the Doric order's shaft.

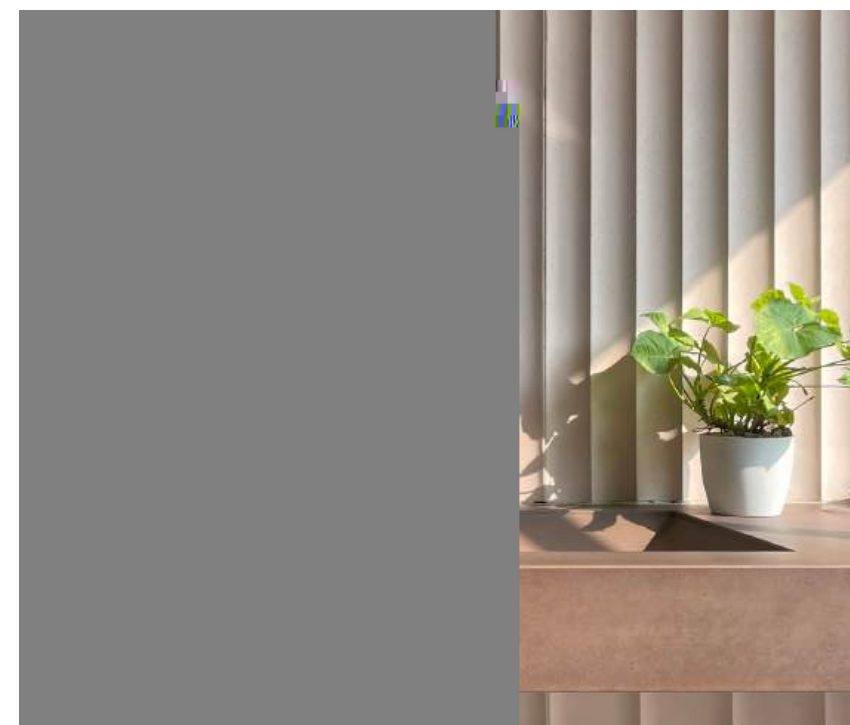
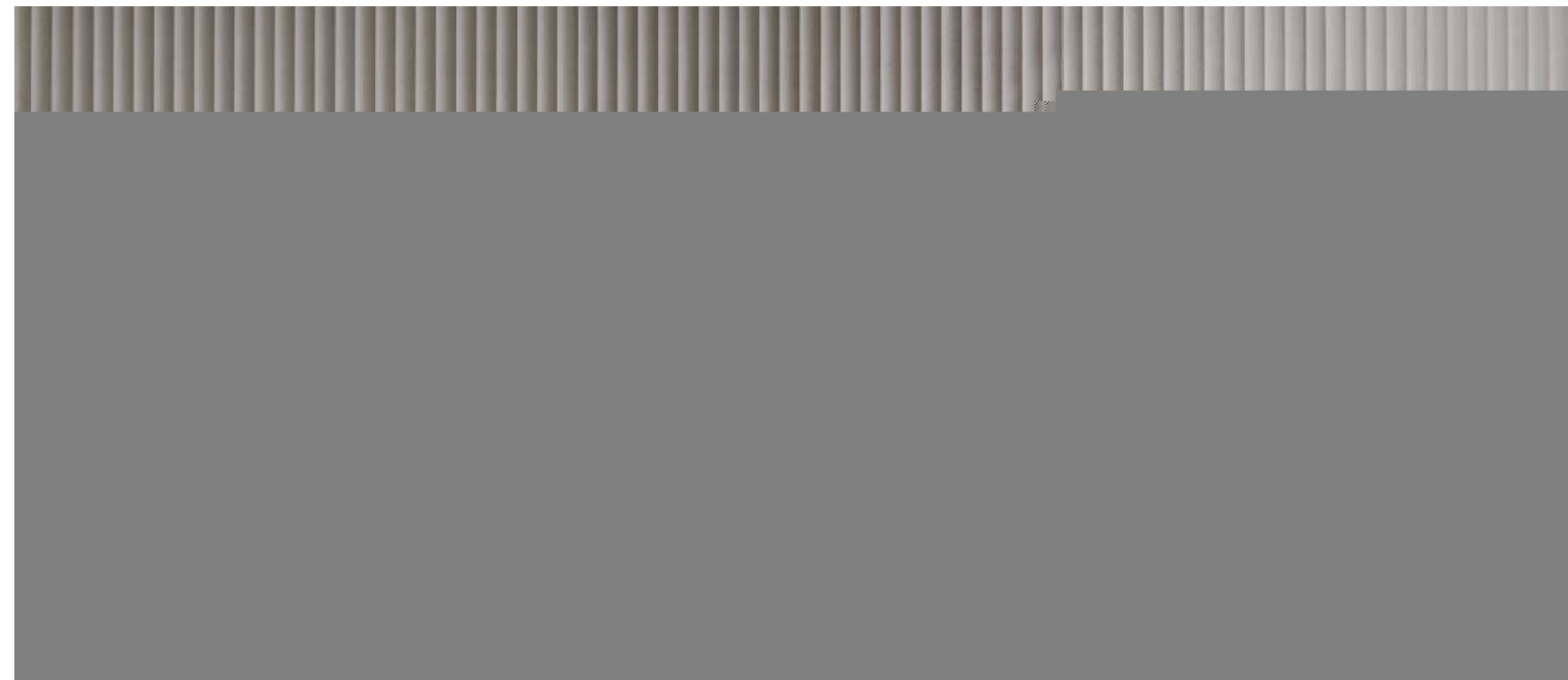

DIMENSIONS

MODULES

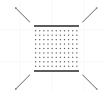

X-LARGE FORMAT

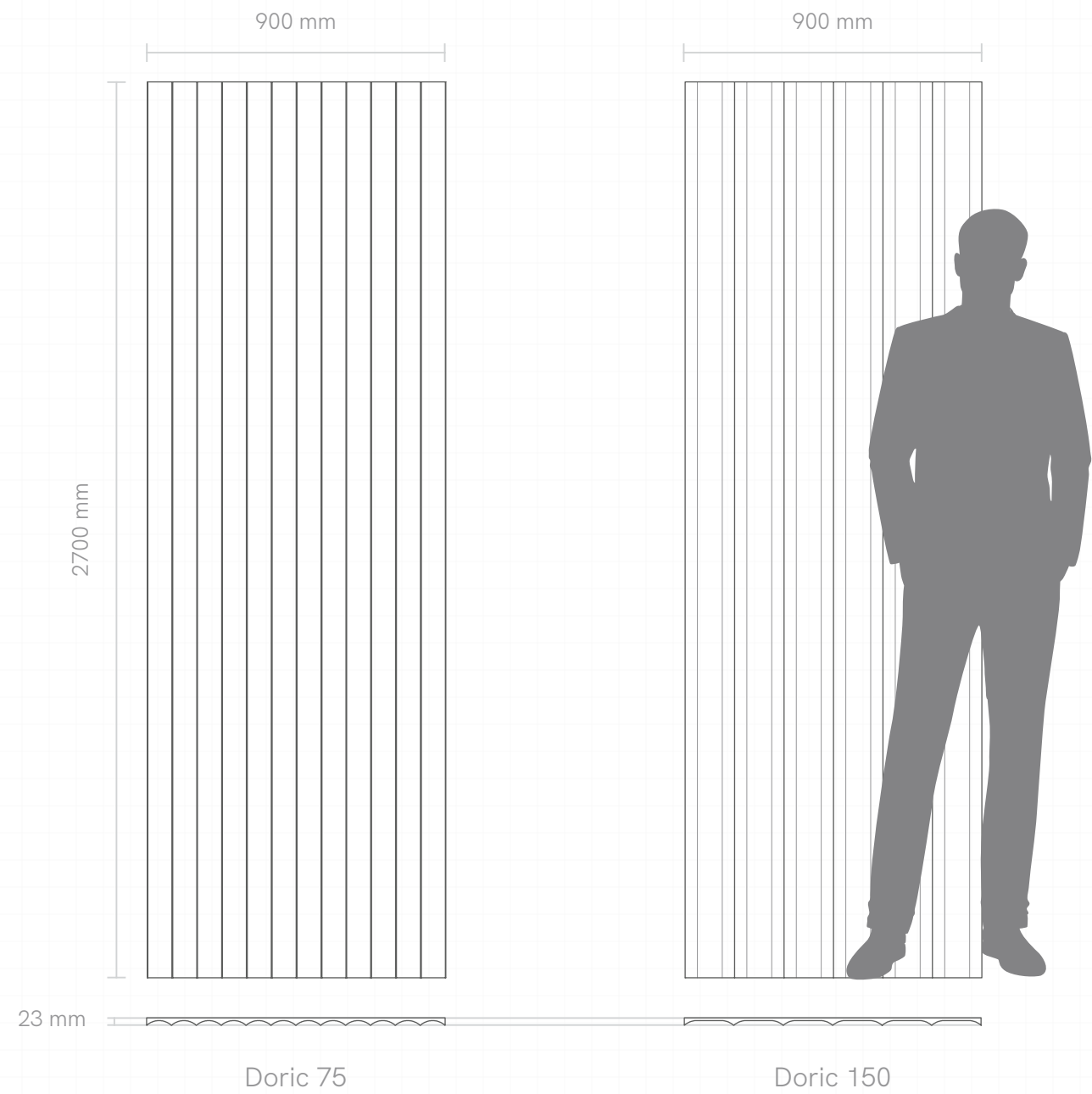

INSTALLATION PATTERNS

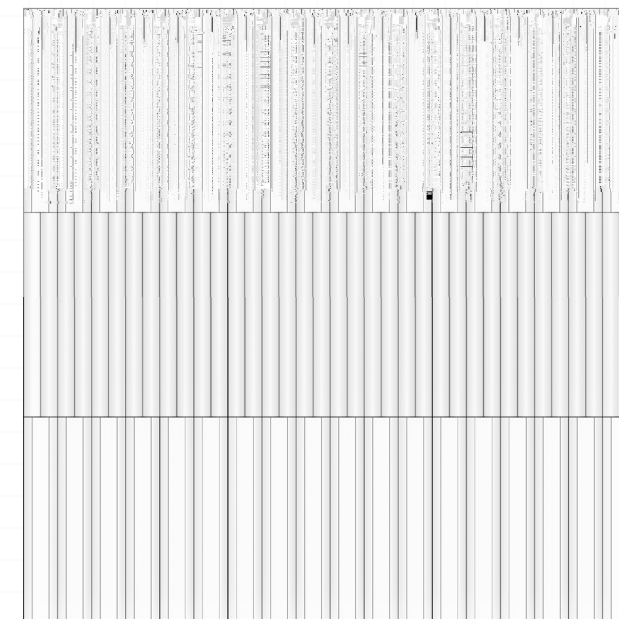
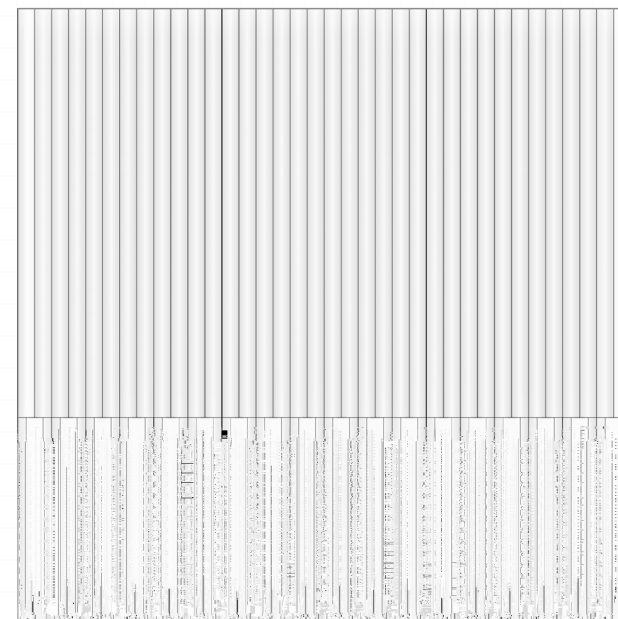
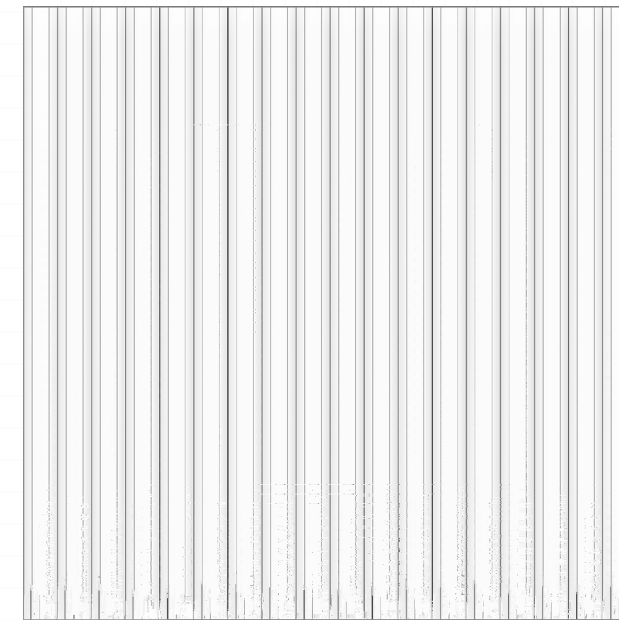
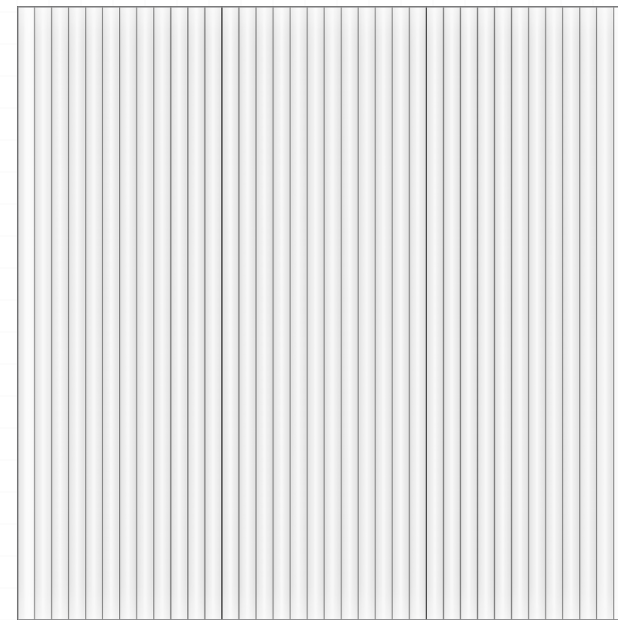

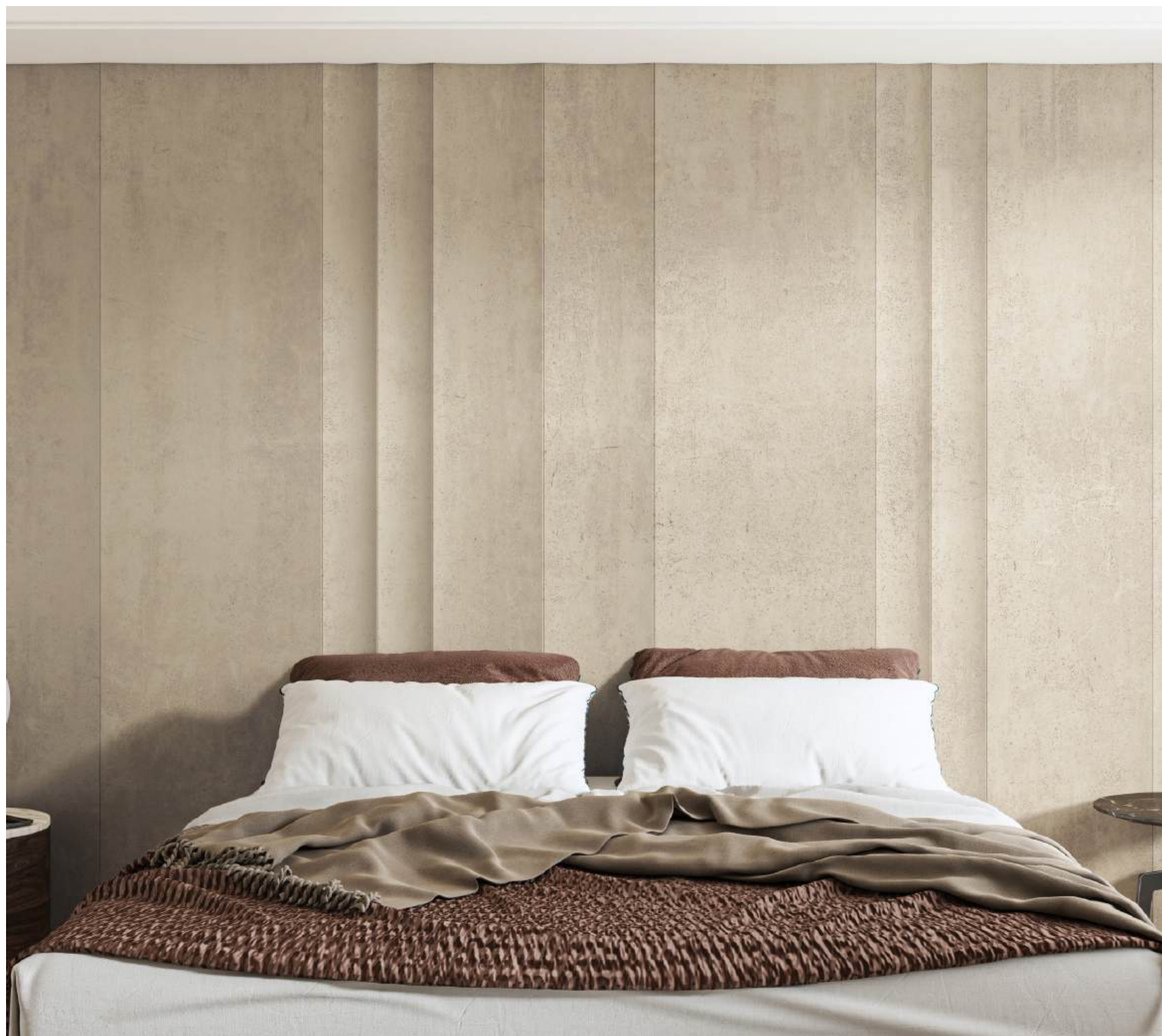

PALARIC

Inspired by the timeless allure of flutes, our Palaric Wall Panels offer a fresh perspective on unbalanced harmony. Designed to ignite the imagination, these panels embrace dissimilarity to unveil a world of seamless possibilities. A wall that commands attention and effortlessly blends into your space with undeniable authority.

Embrace the allure of unconventional luxury with Palaric Wall Panels. Elevate your space with minimalistic sophistication and unparalleled elegance.

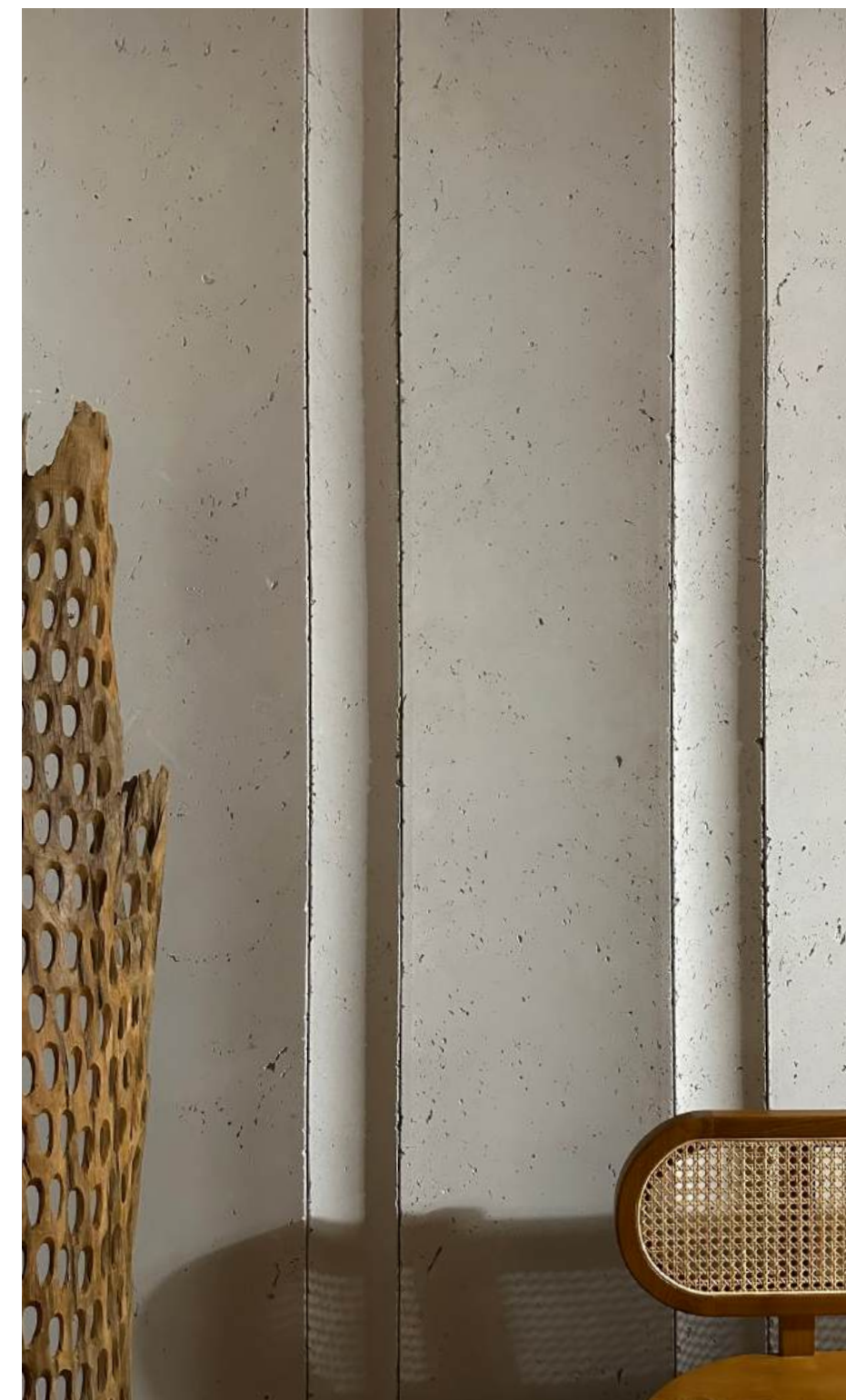

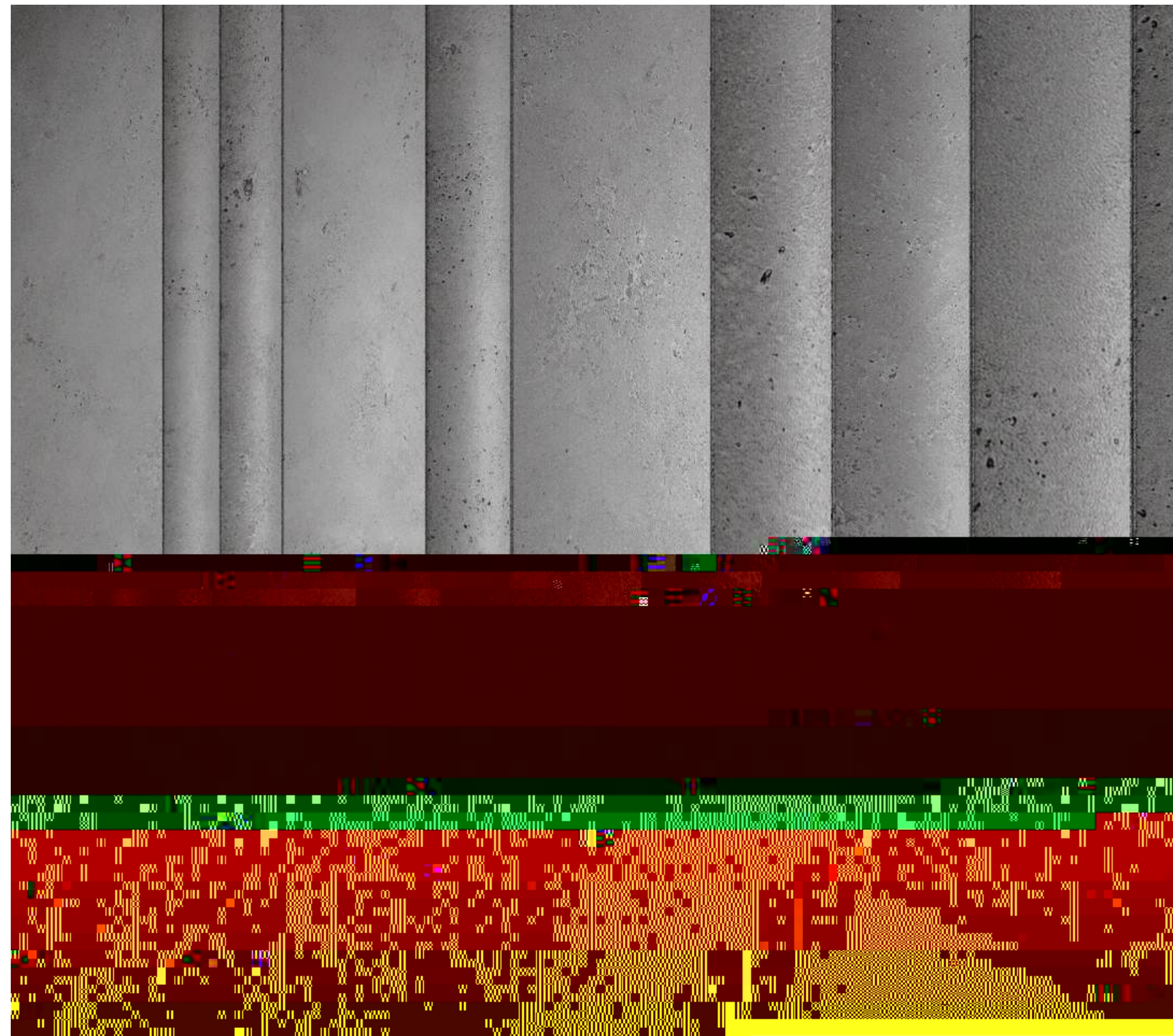

DIMENSIONS

MODULES

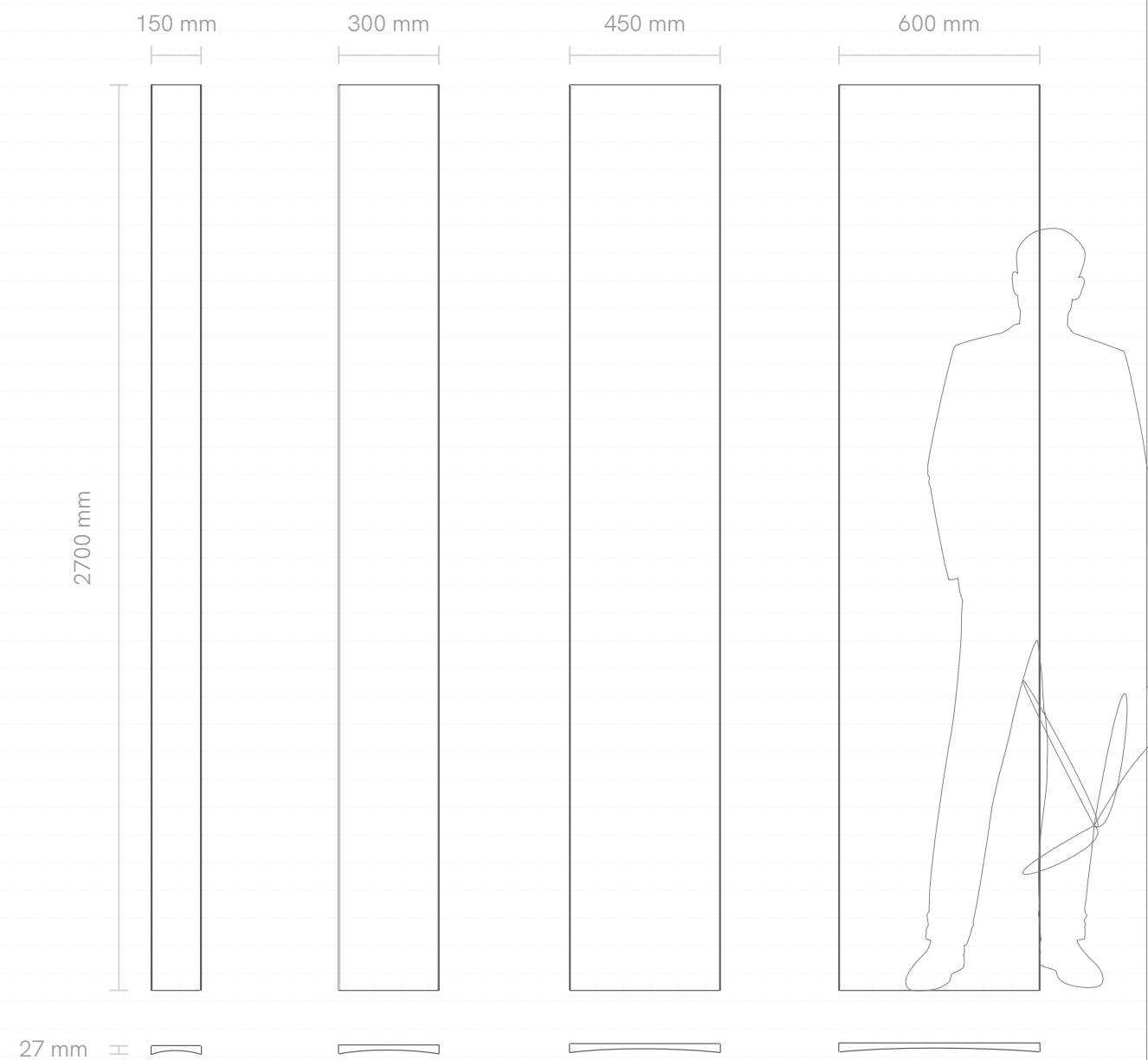

INSTALLATION PATTERNS

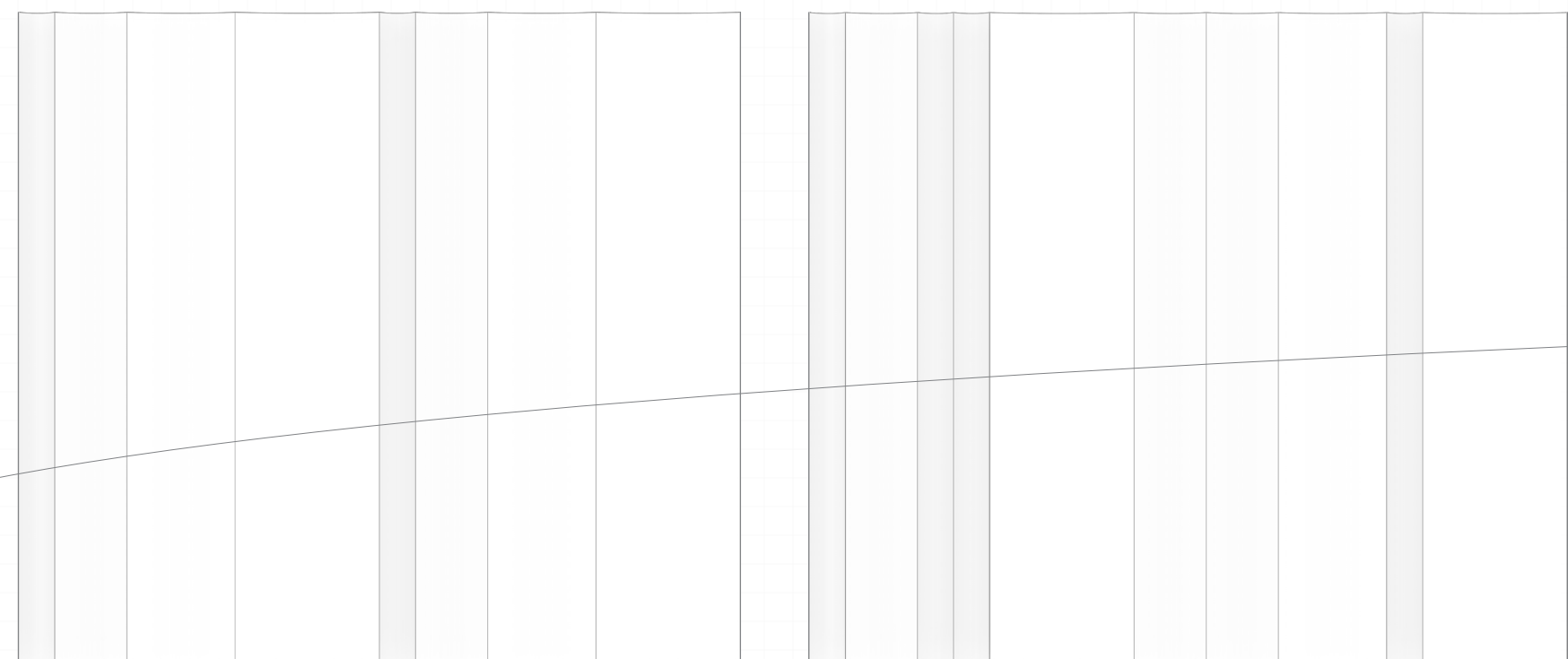

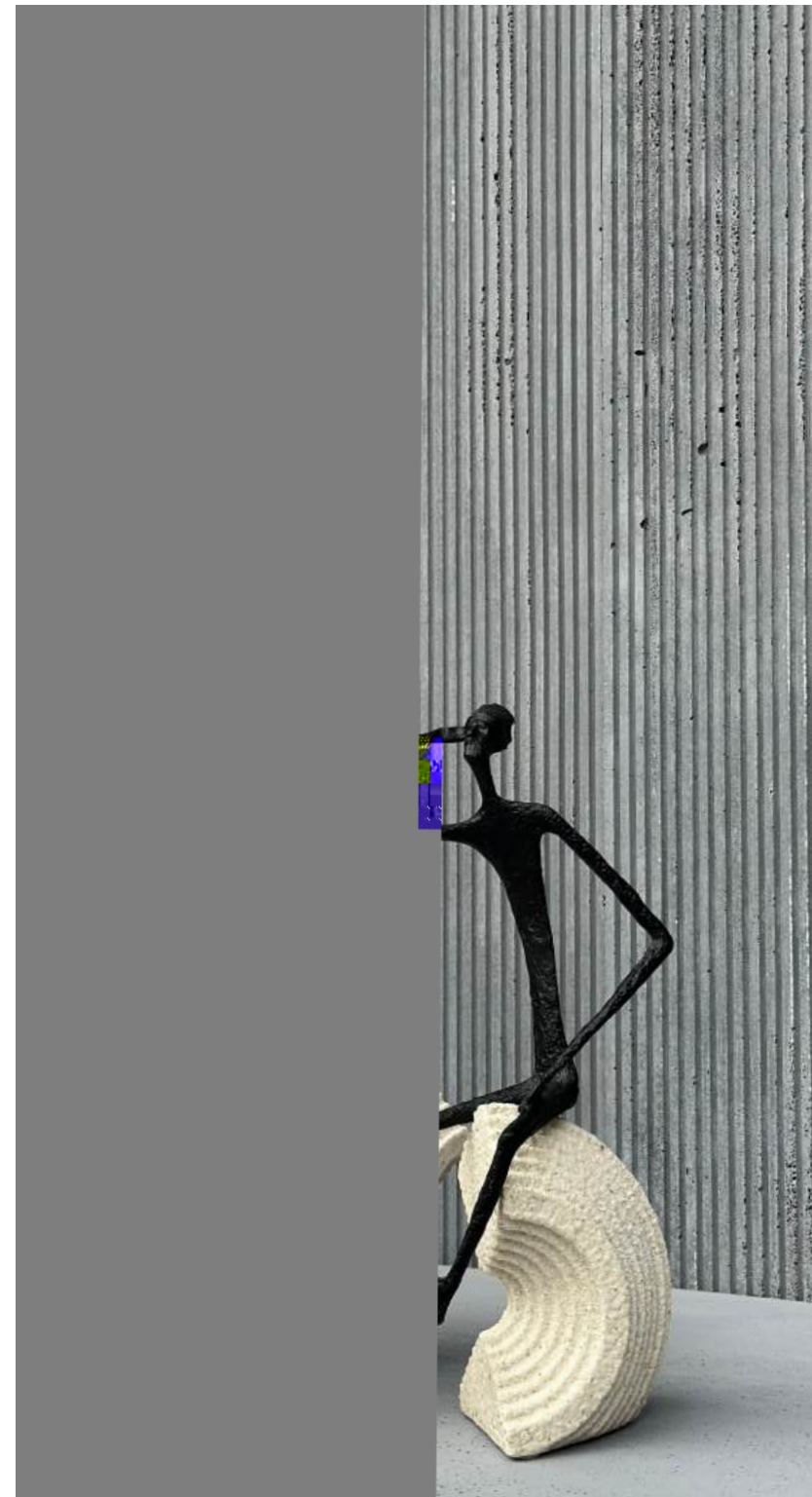
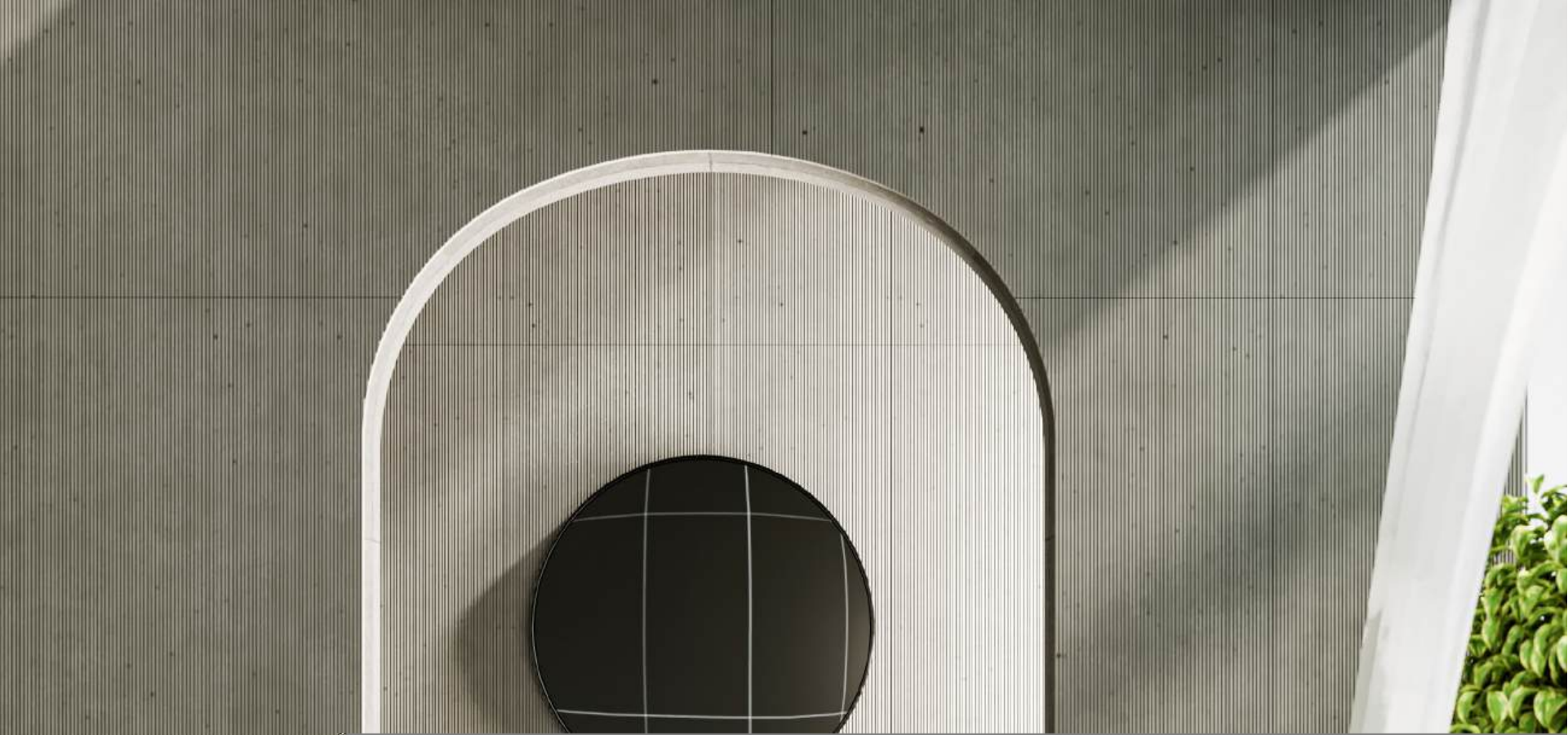

CONFINI

Simplicity is the epitome of beauty. For those who appreciate aesthetics, the clean and minimal design of Confini speaks volumes. Yet, its appeal extends far beyond, captivating all who encounter it.

Crafted with simple thin fluted straight lines, Confini wall panels are a delight to both the visual and touch senses. This series offers a subtle enhancement to your living space, seamlessly integrating without overpowering the existing aesthetic.

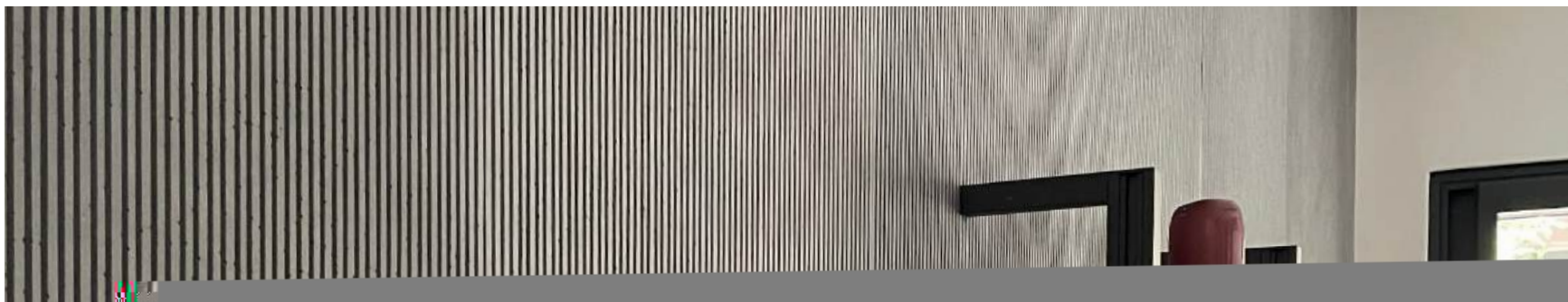



DIMENSIONS

MODULES



LARGE FORMAT

INSTALLATION PATTERNS

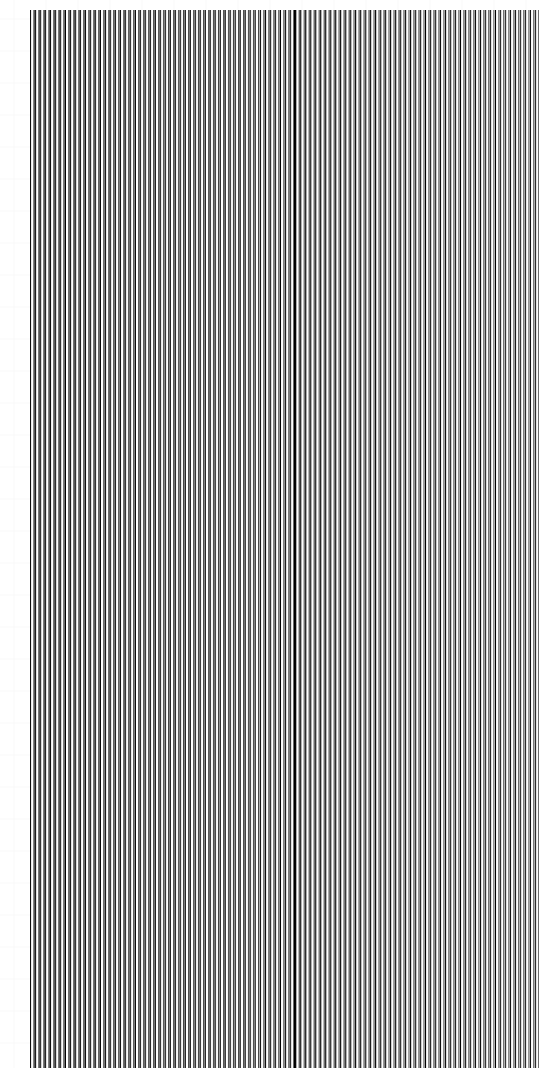
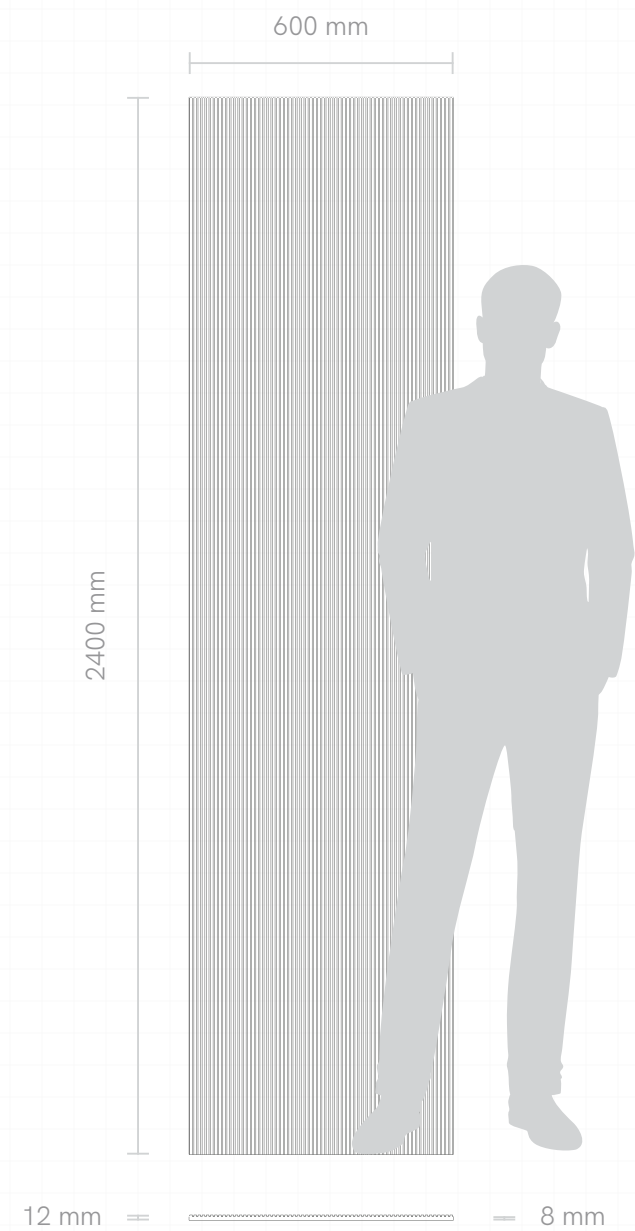

RIBBED

Crafted at the intersection of geometric precision and computational creativity, these panels epitomize the essence of parametric design. Each panel is a testament to meticulous craftsmanship, sculpted with algorithmic finesse to seamlessly blend raw, natural allure with contemporary architectural finesse.

Behold as light dances upon the intricate contours and protuberances, orchestrating a mesmerizing play of shadows and highlights. Every ripple, every curve, whispers tales of elegance and sophistication, making a bold statement in any space.





DIMENSIONS

MODULES

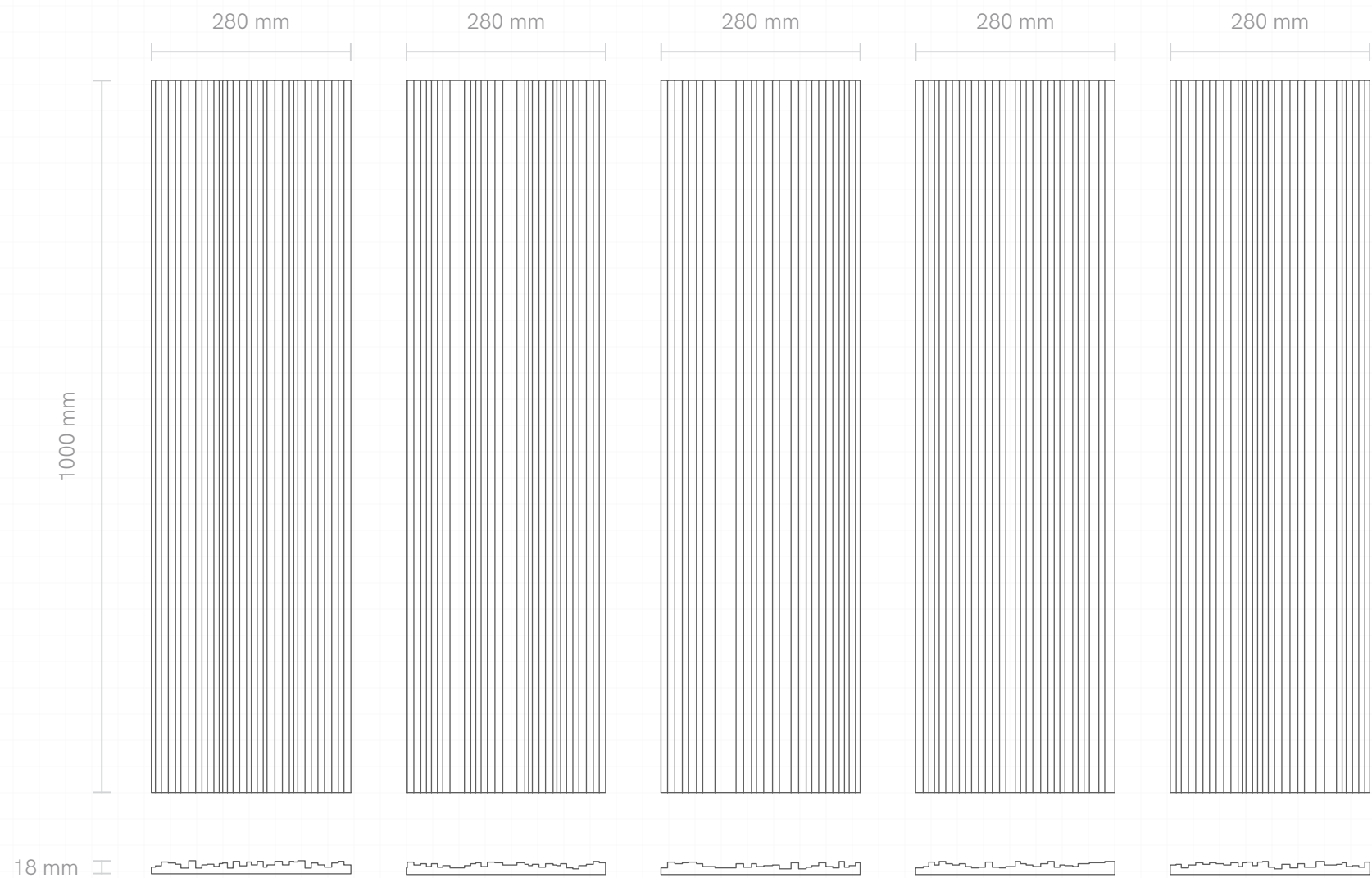

INSTALLATION PATTERNS

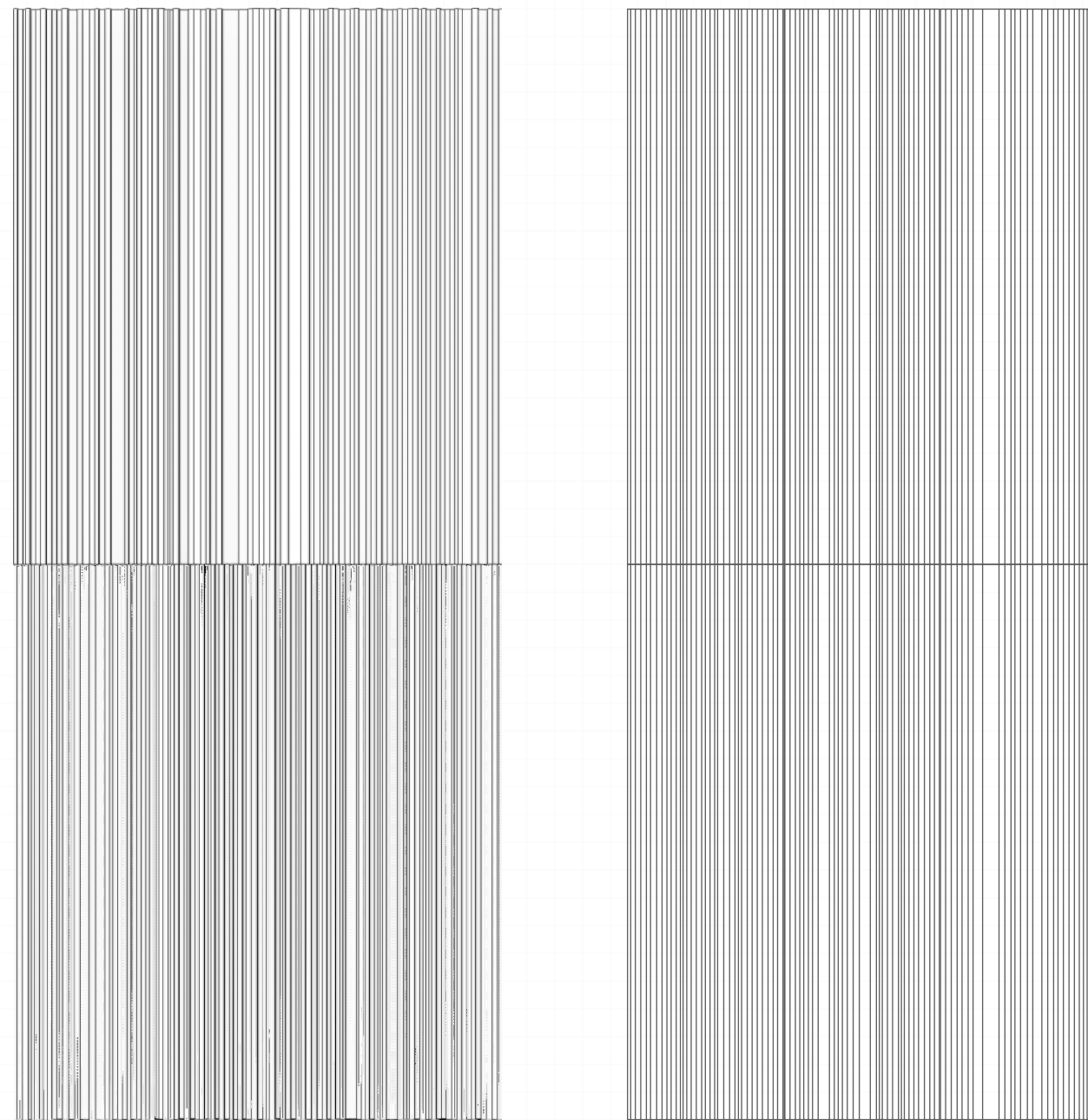

ILLUMINATE SERIES

Light plays a pivotal role in setting the mood especially indoors. Considering the need and effectiveness of light integrated wall panels we have developed the Illuminate Series. The epitome of ambient lighting; Illuminate Series offers the best in class designer wall panels.



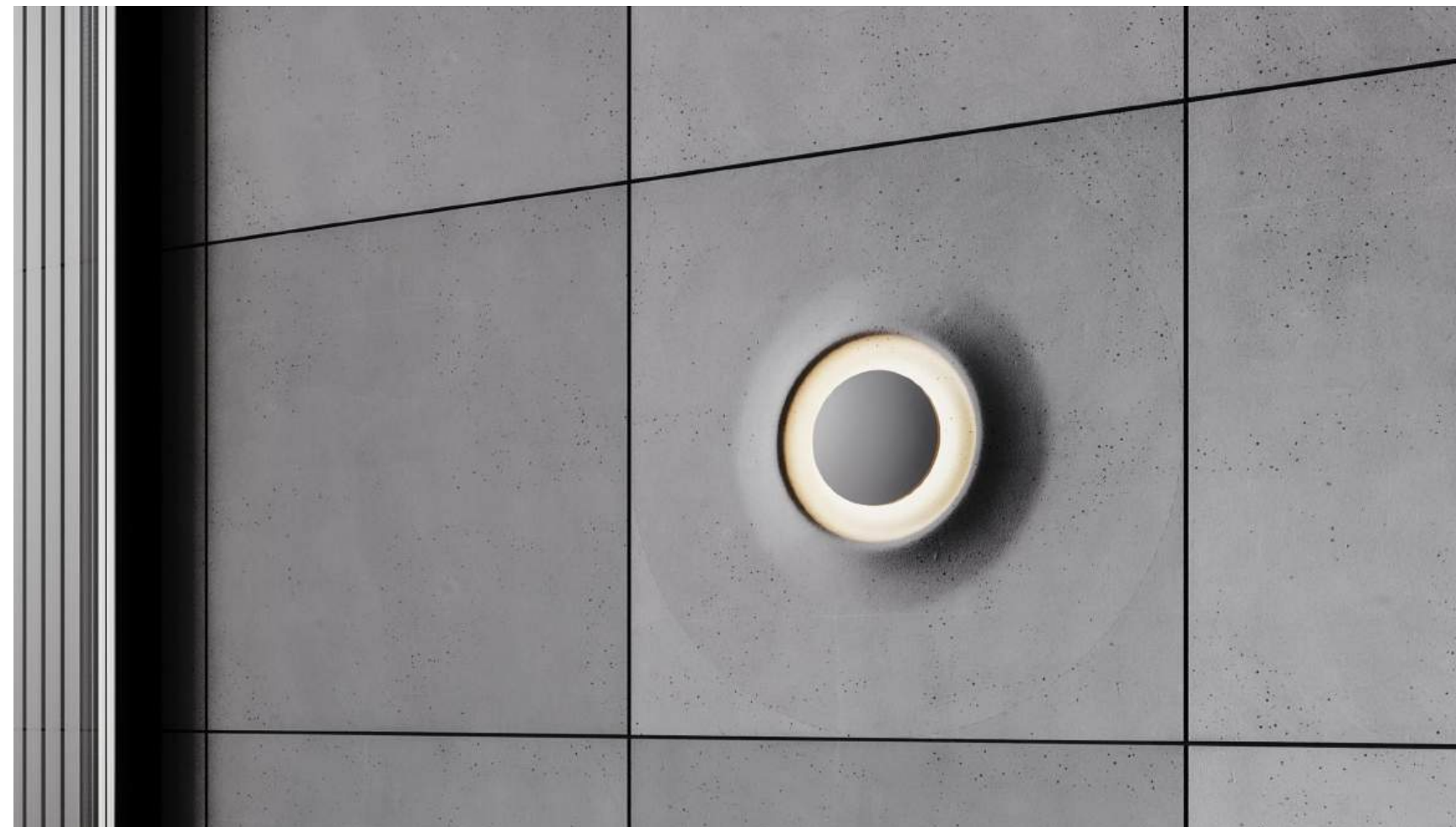

HALO ECLIPSE

Crafted at the intersection of geometric precision and computational creativity, these panels epitomize the essence of parametric design. Each panel is a testament to meticulous craftsmanship, sculpted with algorithmic finesse to seamlessly blend raw natural allure with contemporary architectural finesse.

Behold as light dances upon the intricate contours and protuberances, orchestrating a mesmerizing play of shadows and highlights. Every ripple, every curve, whispers tales of elegance and sophistication, making a bold statement in any space.

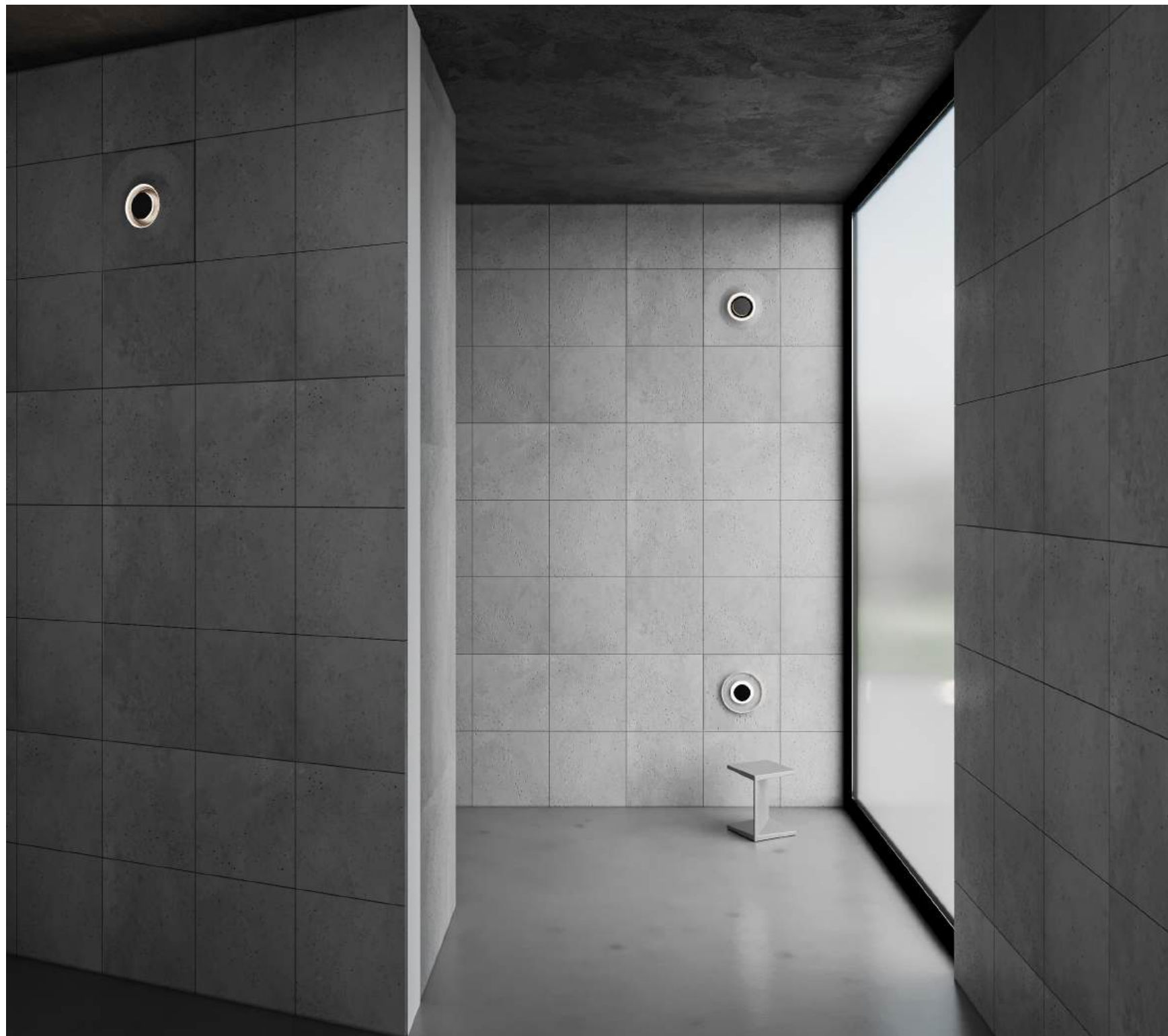

DIMENSIONS

MODULES

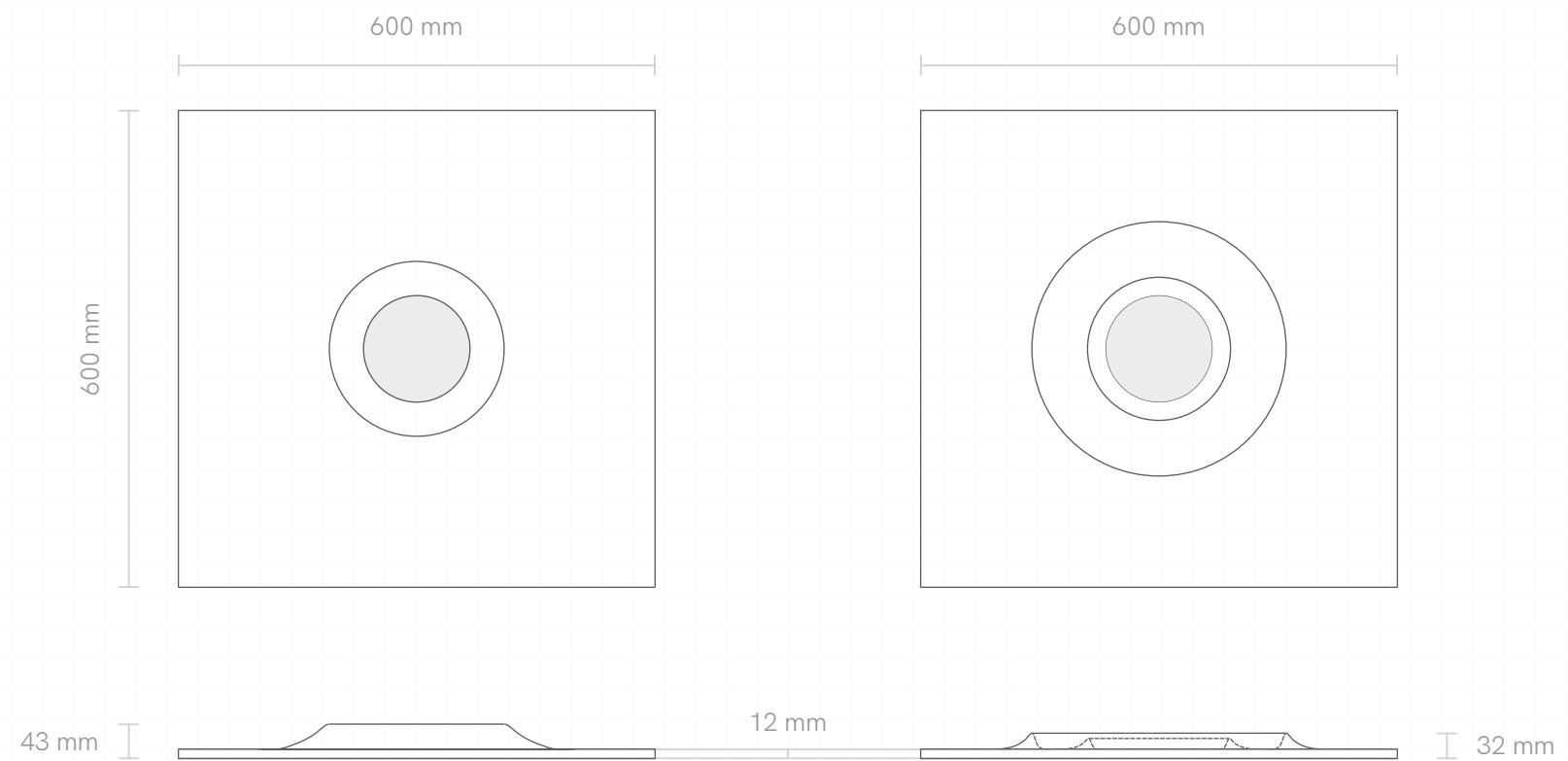

INSTALLATION PATTERNS

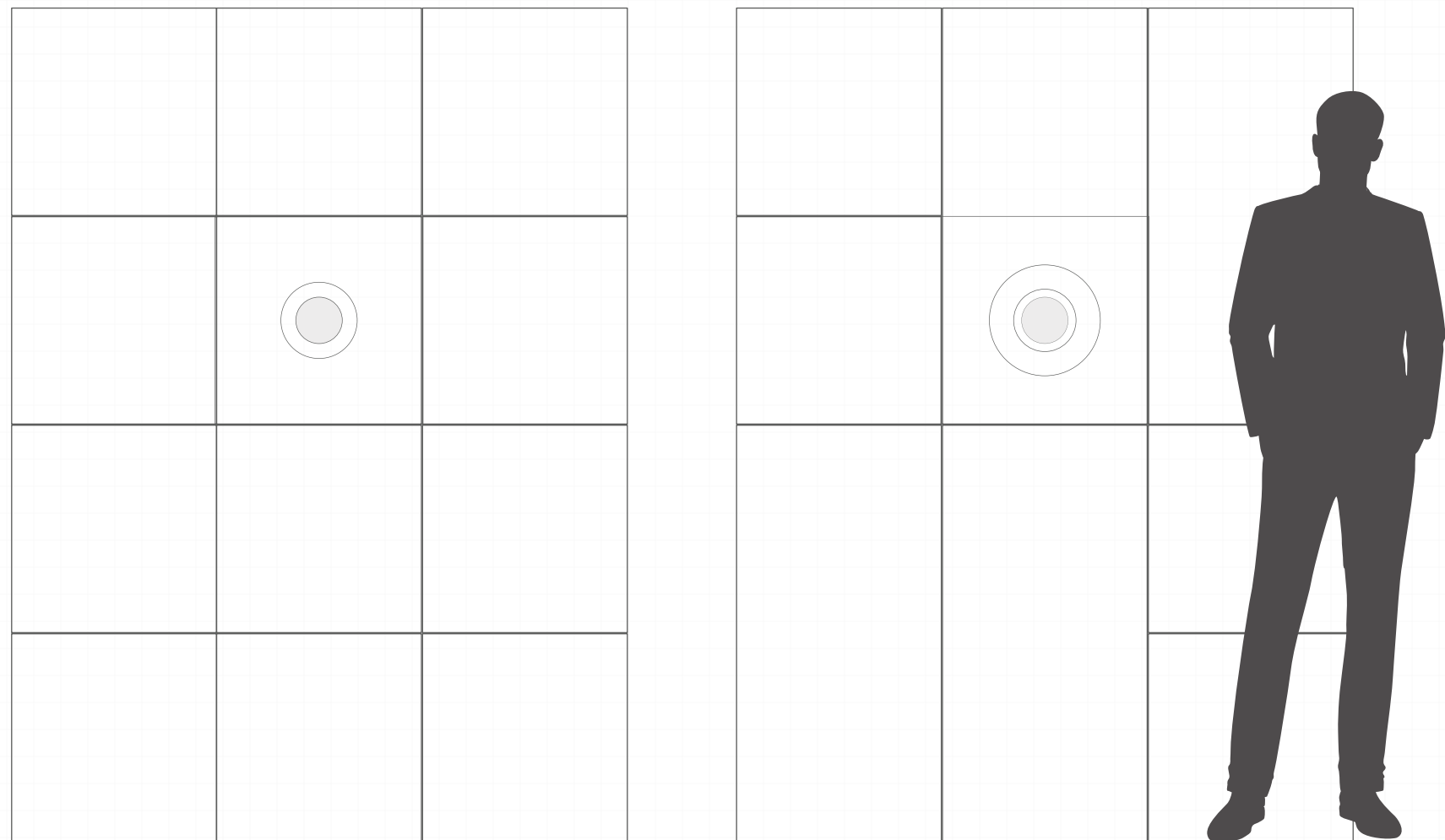

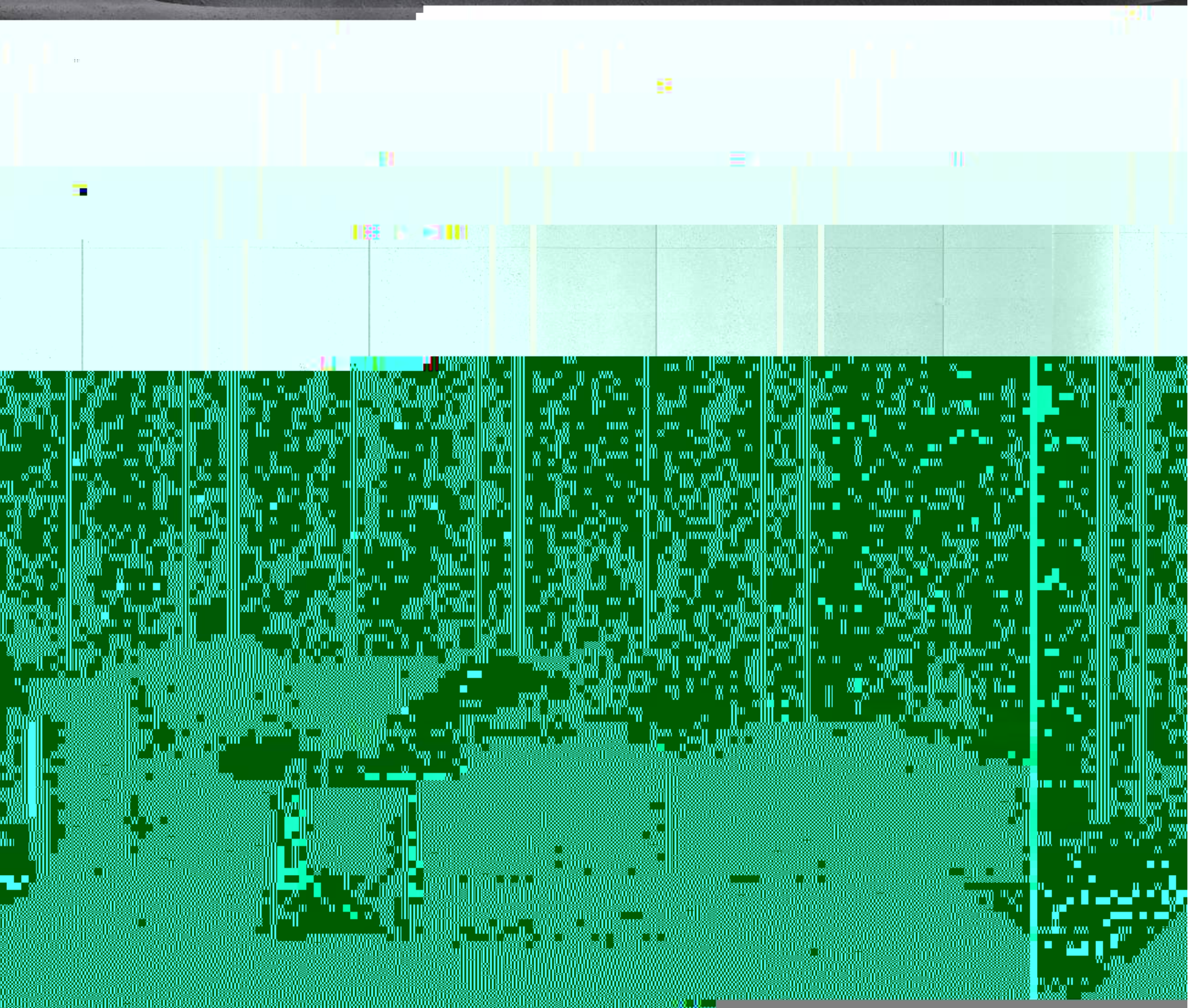

VERTIGLOW

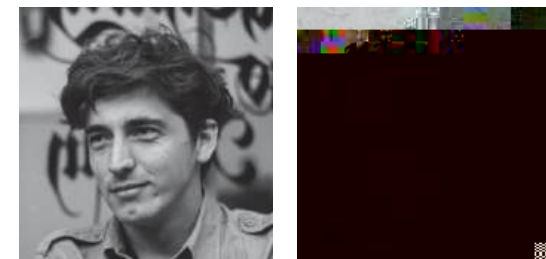

Designer: Diego and Leonardo (Argentina)

A paradigm of simplicity and versatility in lighting design. Enhanced with innovative lighting elements, Vertiglow panels offer unparalleled flexibility to create diverse and captivating scenes. Perfect for accent lighting, task lighting, and ambient lighting, these panels provide an effortless solution for designers aiming to craft unique atmospheres in any space.

The standout feature of Vertiglow panels is their remarkable versatility. By combining various lighting options, they deliver a wide range of effects, allowing you to tailor the lighting to suit different moods and needs. Whether highlighting architectural features, providing focused task illumination, or setting a soothing ambient glow, Vertiglow panels excel in every application.

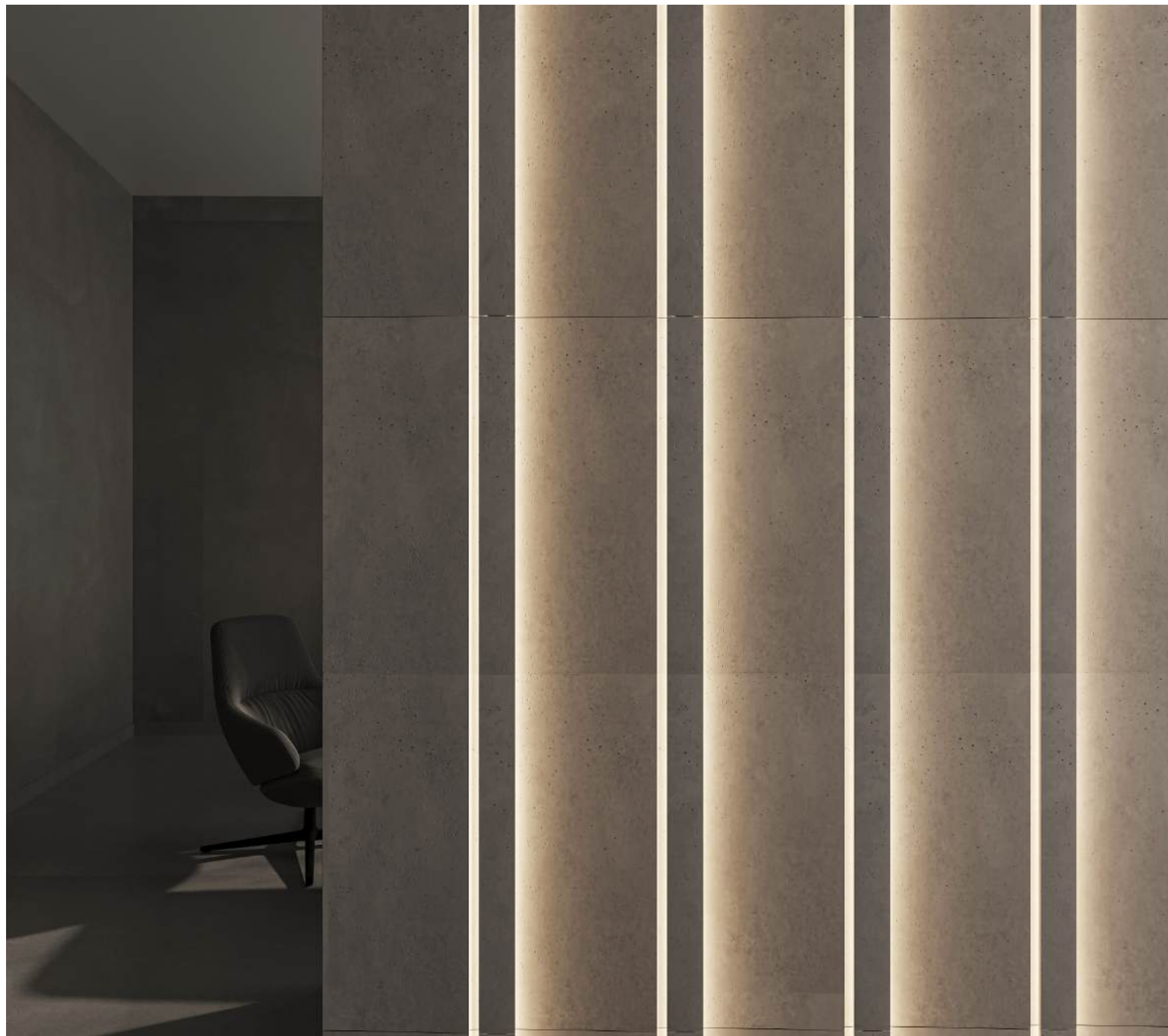

DIMENSIONS

MODULES

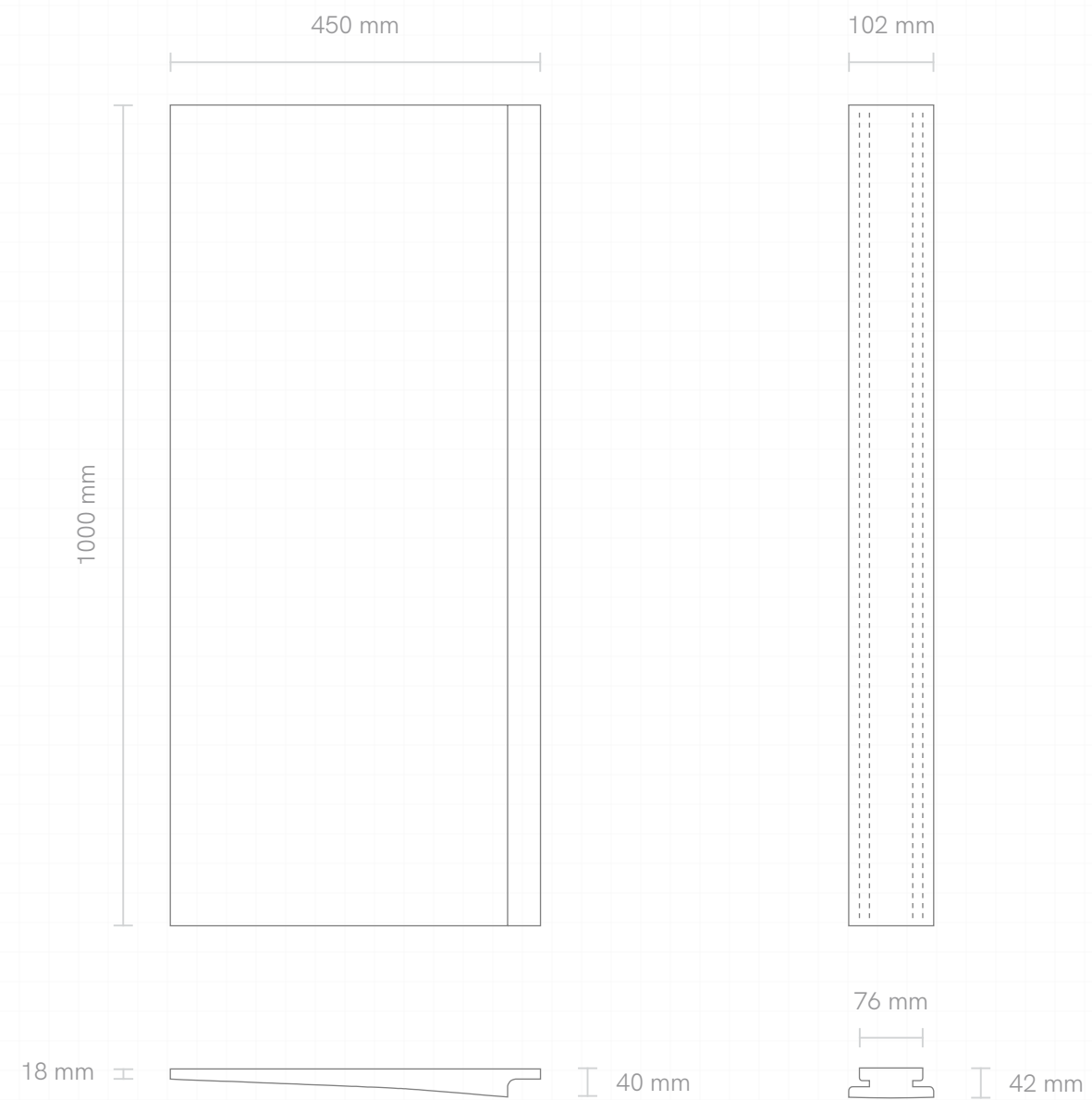

INSTALLATION PATTERNS

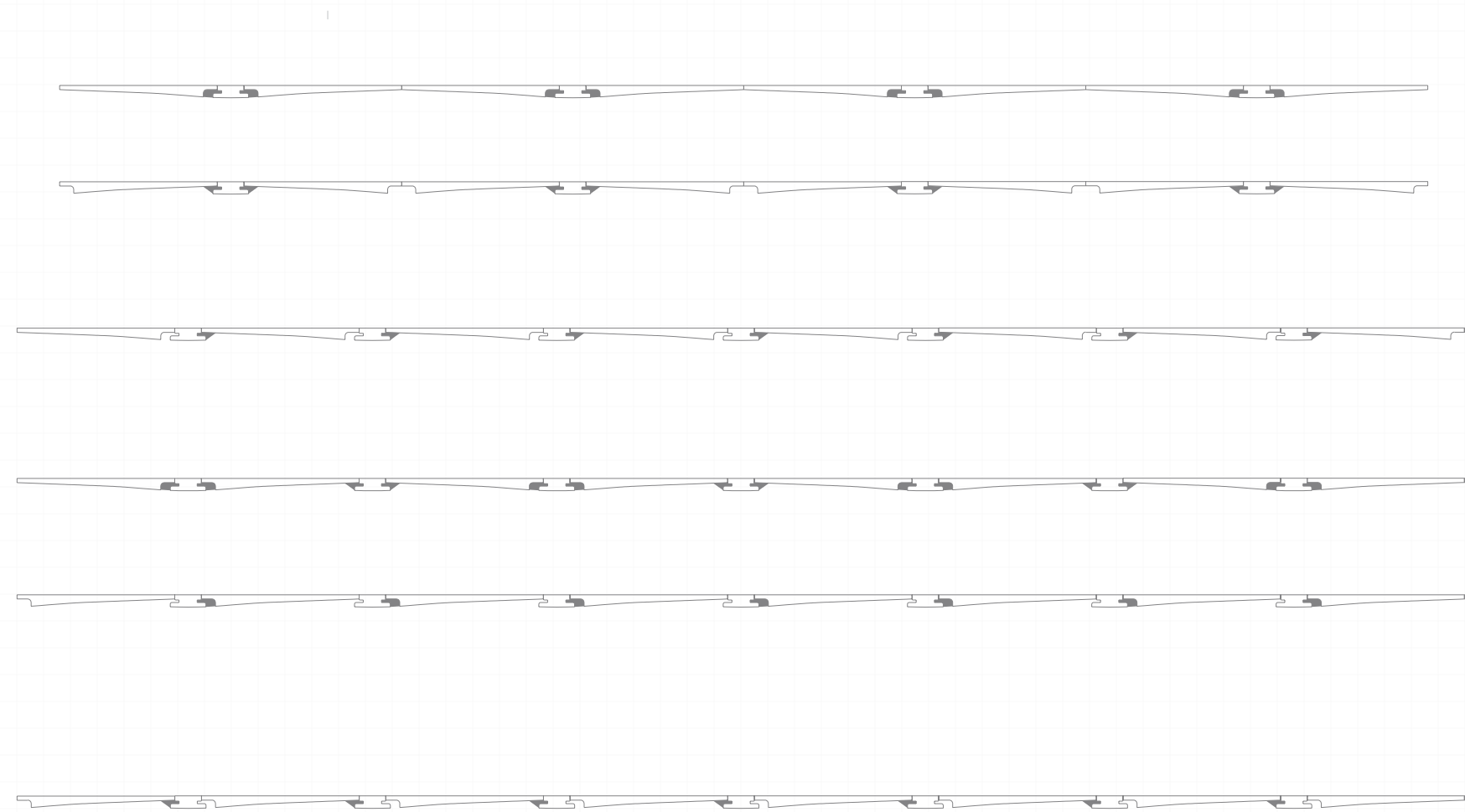

TEXTURES



Natural

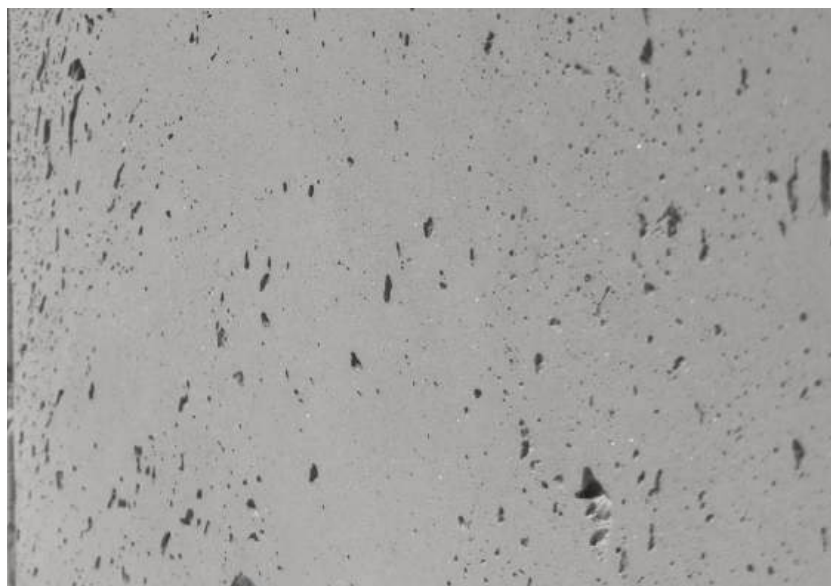

Travertine



Distressed



Porous

COLORS

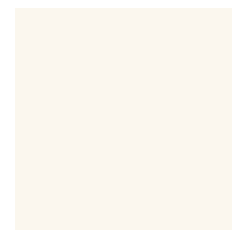

Earth White

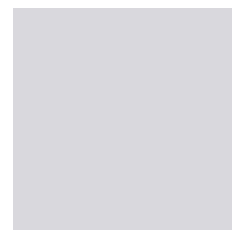

Iced Steel



Melted Alloy



Charcoal



Urban Taupe



Indian Grey



Hushed Cream



Nomadic Beige



Powdered Mocha



Purple Ore



Powdered Pink



Burnt Orange



Blue Fog



Prussian Blue



Sage Green



Ochre

Color Disclaimer:
 Despite every effort to accurately match each products's color when manufactured, actual colors may vary.
 This is a natural trait of concrete. The tonal differences complement its appearance. Color matches cannot be guaranteed.

HANDLING AND STORAGE

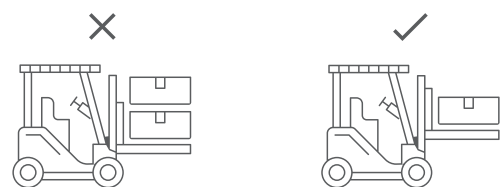

USING FORKLIFTS

Use fork lifts for loading and unloading the crates. Ensure that the crate is well balanced and centered to the fork of the forklift. It is not advisable to stack multiple crates while loading and unloading.



STACKING PANELS

Panels/boxes have to be stacked next to each other, perpendicular to the ground. The longer edge of the panels/boxes should face the ground. The panels should never be stacked horizontally on top of one another. This may damage the panels.

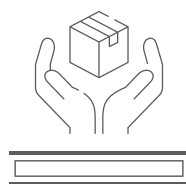

HANDLE WITH CARE

Litheoz panels need to be handled with care. Gloves must be clean, oil and grease can stain the panel surface.

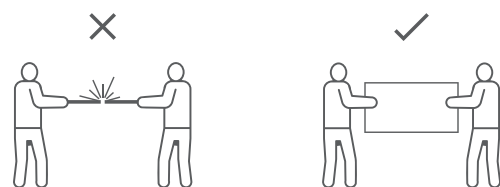

MOVING PANELS

Panels/boxes should be lifted and moved vertically with the longer edge facing the ground. Lifting and moving the panels with one face parallel to the ground may lead to bending and breaking of panels.

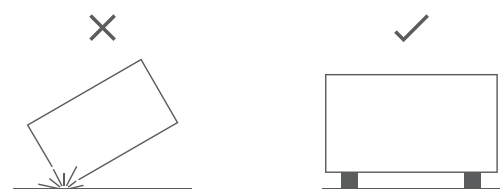

STORING PANELS

The panels should be placed on two wooden planks on the ground as shown in the figure. The panels could be damaged if placed directly on the ground. The edges and corners of the panels/boxes should not collide with the floor of the walls while handling, this may damage the panels.



KEEP DRY

Litheoz panels need to be protected from moisture at the job-site and in long-term storage.

TECHNICAL SPECIFICATIONS

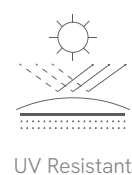

UV Resistant



100% Recyclable

SIZE

Variation of 1% can be expected in the dimension of the Litheoz panels. For appropriate alignment of the panels during installation, use of spacers is highly advised.

CRACKS

Visible cracks on the panels are considered as defects caused with improper handling while storing or transportation. Hairline cracks on the panels are not considered to be defects. They are a natural characteristic of the material and do not tamper with the functionality. These cracks which are developed over the years are minute, surficial and generally not visible to the naked eye.

SMOOTH NATURAL

The Litheoz panels with this texture is one of our most sophisticated yet earthy offerings. You can expect a few small pinholes on the surface of the panel. This is not considered a defect.

PINHOLES AND AIR BUBBLES

Concrete naturally has some air trapped in it while manufacturing. The occurrence of hole/bubbles is an inherent attribute of the material. Therefore no panels are imitable.

THICKNESS

Variation of 10% can be expected in the thickness of the Litheoz panels.

INSTALLATION PROCEDURES

USING ADHESIVE WET & DRY WALL CLADDING

Nuance Studio Concrete Wall Panels can be installed on concrete plastered walls as well dry walls such as plywood and other board partition walls.

Ensure the surface of the wall is as clean and flat as possible on which the panels are being installed. The tiling pattern should be marked on the walls before installing the panels to ensure the right tessellation pattern is achieved. Recommended wall adhesive needs to be used for installing the concrete panels. Different type of adhesives are used to install the concrete panels based on the substrate, height of installation and other factors. Please connect with us for specific details.



WET CLADDING METHOD

Wet Cladding method is used for installing Nuance Studio Concrete Panels on cement plastered walls. \$1 class cement-based adhesives are used in this method. The back of the concrete panels should be primed with a priming liquid polymer before cladding.

DRYWALL CLADDING METHOD

Drywall Cladding method is used for installing Nuance Studio Concrete Panels on substrates such as plywood and other board partitions and walls. Drywall adhesives predominantly have A&B components mixed together without using water. Drywall application is less dusty and messy by process.

For Wet Cladding and Drywall cladding, same procedure is followed from here on.

While starting installation, completely butter the back of the concrete panel with a very thin layer of adhesive. Apply the tile adhesive on the installation wall and the back of the Concrete Wall Panel using a notched trowel and install the panels as regular practice.

Use of spacers is recommended for installation. The spacer gaps should be filled with superior quality tile grout / sealant where the surface is subjected to moisture and water contact. The tile edges need to be masked using 1" non- marking masking tape before grouting. The marking tape needs to be removed immediately after the grout is applied. The front surface of the Concrete Panels should be kept clean and away from contact of adhesive and grout, as it may permanently stain the surface. In-case of any residue of the adhesive or grout settling on the surface of the panel, the residue should be wiped off and cleaned immediately to avoid any sorts of stains.

The spacer gaps can be left unfilled in interior application for aesthetic reasons.

Spot bonding of the adhesive is absolutely not recommended for any type of installation.

Mechanical clamps along with adhesive is recommended to be used for multilevel and exterior wall panel installations. Mechanical clamps ensure safety of the installation in higher heights and in varied climatic conditions. Please contact the company for more details.





udio.com
studio.com